



HEAD LAMPS



REFERENCE:
L0150

DRIVING LAMP 6X LED

WARNINGS FOR THE USER:

- Do not look directly into the light - it may cause damage or even loss of vision.
- Install only in specialized workshops or professional services.
- Use in open space only.
- Use in accordance to the purpose.

INSTALLATION INSTRUCTIONS:

- It should be used exclusively in accordance with intended use.
- Mount exclusively in specialized workshops.
- The connection between the lamp and vehicle's installation should be isolated with heat-shrink tube or alternatively with isolating tape to avoid getting water and moisture to the copper wire of the lamp which can damage electronic components. When it comes to lamp and plug, the plug should be mounted safely.
- Do not cut off tinned ends.
- Lamps must be installed only in accordance with UNECE regulations.



PHOTO AND TECHNICAL DRAWING:

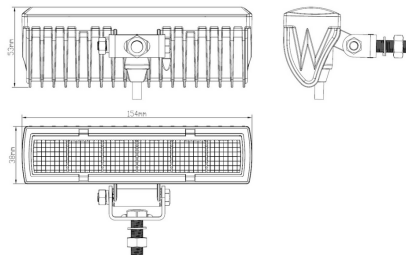

TECHNICAL SPECIFICATIONS:



MATERIAL	LED/LM QUANTITY	MOUNTING	WIRE	FUNCTION	WATT	VOLTAGE	CERTIFICATES	PACKING - BULK BOX
<ul style="list-style-type: none"> » Lens: PC » Housing: AL 	<ul style="list-style-type: none"> » 6 LED 	<ul style="list-style-type: none"> » screws 	<ul style="list-style-type: none"> » 300 mm 	<ul style="list-style-type: none"> » work light » flood 	<ul style="list-style-type: none"> » 16W 	<ul style="list-style-type: none"> » 12V/24V 	<ul style="list-style-type: none"> » ECE R10 » ECE R112 	<ul style="list-style-type: none"> » cart. dim.: 102x55,5x109mm » weight: 350g » 40 pcs/bulk box



REFERENCE: L3411

DRIVING LAMP WITH POSITION LED RING 62X LED

WARNINGS FOR THE USER:

- Do not look directly into the light - it may cause damage or even loss of vision.
- Install only in specialized workshops or professional services.
- Use in open space only.
- Use in accordance to the purpose.

INSTALLATION INSTRUCTIONS:

- It should be used exclusively in accordance with intended use.
- Mount exclusively in specialized workshops.
- The connection between the lamp and vehicle's installation should be isolated with heat-shrink tube or alternatively with isolating tape to avoid getting water and moisture to the copper wire of the lamp which can damage electronic components. When it comes to lamp and plug, the plug should be mounted safely.
- Do not cut off tinned ends.
- Lamps must be installed only in accordance with UNECE regulations.



PHOTO AND TECHNICAL DRAWING:

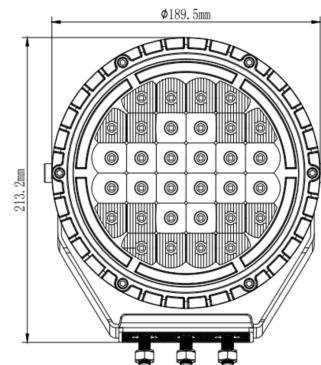

TECHNICAL SPECIFICATIONS:



MATERIAL	LED/LM QUANTITY	MOUNTING	WIRE	FUNCTION	WATT	VOLTAGE	CERTIFICATES	PACKING/WEIGHT
<ul style="list-style-type: none"> » Lens: PC » Housing: AL 	<ul style="list-style-type: none"> » 62 LED » 4858 LM 	<ul style="list-style-type: none"> » screw 	<ul style="list-style-type: none"> » 250mm 	<ul style="list-style-type: none"> » position » driving light 	<ul style="list-style-type: none"> » 5 W » 68W 	<ul style="list-style-type: none"> » 12 V/24V 	<ul style="list-style-type: none"> » ECE R7 » ECE R10 » ECE R112 	<ul style="list-style-type: none"> » cart. dim.: 245x220x145mm » weight: 2000g » 12 pcs/bulk box



REFERENCE:
L3412

HEAD LAMP LED + POSITION LED
TL 1224V

WARNINGS FOR THE USER:

- Do not look directly into the light - it may cause damage or even loss of vision.
- Install only in specialized workshops or professional services.
- Use in open space only.
- Use in accordance to the purpose.

INSTALLATION INSTRUCTIONS:

- It should be used exclusively in accordance with intended use.
- Mount exclusively in specialized workshops.
- The connection between the lamp and vehicle's installation should be isolated with heat-shrink tube or alternatively with isolating tape to avoid getting water and moisture to the copper wire of the lamp which can damage electronic components. When it comes to lamp and plug, the plug should be mounted safely.
- Do not cut off tinned ends.
- Lamps must be installed only in accordance with UNECE regulations.



www.myKAMAR.com

PHOTO AND TECHNICAL DRAWING:

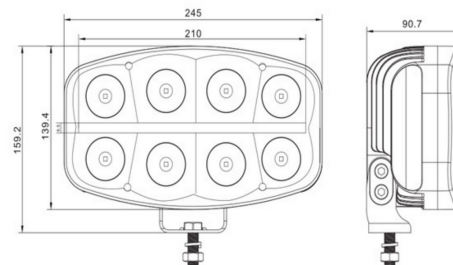

TECHNICAL SPECIFICATIONS:

MATERIAL	LED/LM QUANTITY	MOUNTING	WIRE	FUNCTION	WATT	VOLTAGE	CERTIFICATES	PACKING/WEIGHT
» Lens: PC » Housing: AL	» 18 LED » 4925 LM	» screw	» 350mm	» position » driving light	» 8 W » 55 W	» 12 V/24V	» ECE R7 » ECE R10 » ECE R112	» cart. dim.: 280x210x120mm » weight: 1210g » 12 pcs/bulk box

We reserve the right to change technical data and any errors. Photos and specifications are for reference only, and the actual product may vary slightly. Reproduction in whole or parts of the catalog without written authorization is prohibited.



REFERENCE:
L3413

**HEAD LAMP LED + POSITION
BOTTOM LED TL 1224V**

WARNINGS FOR THE USER:

- Do not look directly into the light - it may cause damage or even loss of vision.
- Install only in specialized workshops or professional services.
- Use in open space only.
- Use in accordance to the purpose.

INSTALLATION INSTRUCTIONS:

- It should be used exclusively in accordance with intended use.
- Mount exclusively in specialized workshops.
- The connection between the lamp and vehicle's installation should be isolated with heat-shrink tube or alternatively with isolating tape to avoid getting water and moisture to the copper wire of the lamp which can damage electronic components. When it comes to lamp and plug, the plug should be mounted safely.
- Do not cut off tinned ends.
- Lamps must be installed only in accordance with UNECE regulations.



PHOTO AND TECHNICAL DRAWING:

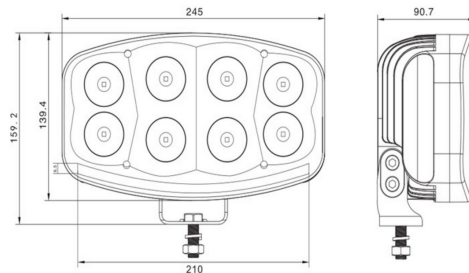

TECHNICAL SPECIFICATIONS:



MATERIAL	LED/LM QUANTITY	MOUNTING	WIRE	FUNCTION	WATT	VOLTAGE	CERTIFICATES	PACKING/WEIGHT
<ul style="list-style-type: none"> » Lens: PC » Housing: AL 	<ul style="list-style-type: none"> » 18 LED » 4925 LM 	<ul style="list-style-type: none"> » screw 	<ul style="list-style-type: none"> » 350mm 	<ul style="list-style-type: none"> » position » driving light 	<ul style="list-style-type: none"> » 8 W » 65 W 	<ul style="list-style-type: none"> » 12V/24V 	<ul style="list-style-type: none"> » ECE R7 » ECE R10 » ECE R112 	<ul style="list-style-type: none"> » cart. dim.: 280x210x120mm » weight: 1210g » 12 pcs/bulk box



REFERENCE:
L3414

HEAD LAMP LED + POSITION LED
BAT 1224V

WARNINGS FOR THE USER:

- Do not look directly into the light - it may cause damage or even loss of vision.
- Install only in specialized workshops or professional services.
- Use in open space only.
- Use in accordance to the purpose.

INSTALLATION INSTRUCTIONS:

- It should be used exclusively in accordance with intended use.
- Mount exclusively in specialized workshops.
- The connection between the lamp and vehicle's installation should be isolated with heat-shrink tube or alternatively with isolating tape to avoid getting water and moisture to the copper wire of the lamp which can damage electronic components. When it comes to lamp and plug, the plug should be mounted safely.
- Do not cut off tinned ends.
- Lamps must be installed only in accordance with UNECE regulations.



PHOTO AND TECHNICAL DRAWING:

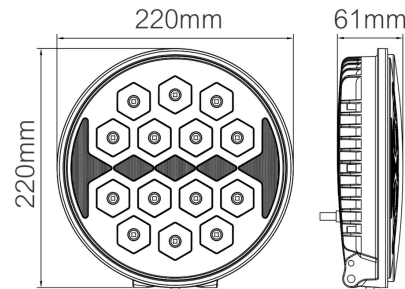

TECHNICAL SPECIFICATIONS:



MATERIAL	LED/LM QUANTITY	MOUNTING	WIRE	FUNCTION	WATT	VOLTAGE	CERTIFICATES	PACKING/WEIGHT
<ul style="list-style-type: none"> » Lens: PC » Housing: AL 	<ul style="list-style-type: none"> » 23 LED » 7480 LM 	<ul style="list-style-type: none"> » screw 	<ul style="list-style-type: none"> » 250mm 	<ul style="list-style-type: none"> » position » driving light 	<ul style="list-style-type: none"> » 1,7 W » 103 W 	<ul style="list-style-type: none"> » 12V/24V 	<ul style="list-style-type: none"> » ECE R7 » ECE R10 » ECE R112 	<ul style="list-style-type: none"> » cart. dim.: 268x95x322mm » weight: 2000g » 10 pcs/bulk box

We reserve the right to change technical data and any errors. Photos and specifications are for reference only, and the actual product may vary slightly. Reproduction in whole or parts of the catalog without written authorization is prohibited.



REFERENCE: L3415

HEAD LAMP LED + DRL LED
1224V

WARNINGS FOR THE USER:

- Do not look directly into the light - it may cause damage or even loss of vision.
- Install only in specialized workshops or professional services.
- Use in open space only.
- Use in accordance to the purpose.

INSTALLATION INSTRUCTIONS:

- It should be used exclusively in accordance with intended use.
- Mount exclusively in specialized workshops.
- The connection between the lamp and vehicle's installation should be isolated with heat-shrink tube or alternatively with isolating tape to avoid getting water and moisture to the copper wire of the lamp which can damage electronic components. When it comes to lamp and plug, the plug should be mounted safely.
- Do not cut off tinned ends.
- Lamps must be installed only in accordance with UNECE regulations.



PHOTO AND TECHNICAL DRAWING:

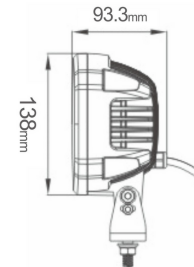
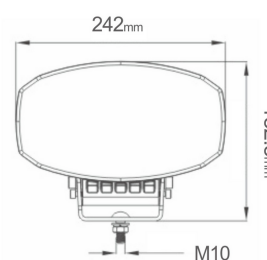

TECHNICAL SPECIFICATIONS:



MATERIAL	LED/LM QUANTITY	MOUNTING	WIRE	FUNCTION	WATT	VOLTAGE	CERTIFICATES	PACKING/WEIGHT
<ul style="list-style-type: none"> » Lens: PC » Housing: AL 	<ul style="list-style-type: none"> » 16 LED » 5800 LM 	<ul style="list-style-type: none"> » screw 	<ul style="list-style-type: none"> » 600mm 	<ul style="list-style-type: none"> » DRL » driving light 	<ul style="list-style-type: none"> » 11,8 W » 58 W 	<ul style="list-style-type: none"> » 12V/24V 	<ul style="list-style-type: none"> » ECE R10 » ECE R87 » ECE R112 	<ul style="list-style-type: none"> » cart. dim.: 280x220x130mm » weight: 2300g » 18 pcs/bulk box



REFERENCE: L3416

HEAD LAMP LED + POSITION LED 1224V

WARNINGS FOR THE USER:

- Do not look directly into the light - it may cause damage or even loss of vision.
- Install only in specialized workshops or professional services.
- Use in open space only.
- Use in accordance to the purpose.

INSTALLATION INSTRUCTIONS:

- It should be used exclusively in accordance with intended use.
- Mount exclusively in specialized workshops.
- The connection between the lamp and vehicle's installation should be isolated with heat-shrink tube or alternatively with isolating tape to avoid getting water and moisture to the copper wire of the lamp which can damage electronic components. When it comes to lamp and plug, the plug should be mounted safely.
- Do not cut off tinned ends.
- Lamps must be installed only in accordance with UNECE regulations.



www.myKAMAR.com

PHOTO AND TECHNICAL DRAWING:

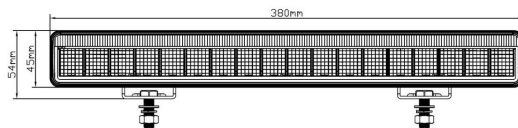
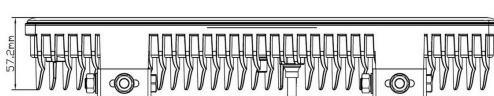
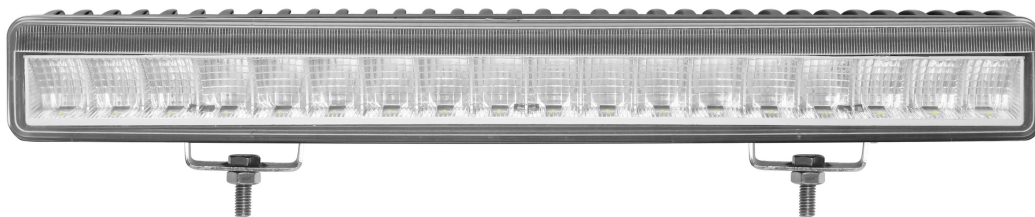

TECHNICAL SPECIFICATIONS:

MATERIAL	LED/LM QUANTITY	MOUNTING	WIRE	FUNCTION	WATT	VOLTAGE	CERTIFICATES	PACKING/WEIGHT
<ul style="list-style-type: none"> » Lens: PC » Housing: AL 	<ul style="list-style-type: none"> » 18+30 LED » 4000 LM 	<ul style="list-style-type: none"> » screw 	<ul style="list-style-type: none"> » 250mm 	<ul style="list-style-type: none"> » position » driving light 	<ul style="list-style-type: none"> » 5W » 45 W 	<ul style="list-style-type: none"> » 12V/24V 	<ul style="list-style-type: none"> » ECE R7 » ECE R10 » ECE R112 	<ul style="list-style-type: none"> » cart. dim.: 405x74x105mm » weight: 1000g » 10 pcs/bulk box

We reserve the right to change technical data and any errors. Photos and specifications are for reference only, and the actual product may vary slightly. Reproduction in whole or parts of the catalog without written authorization is prohibited.



REFERENCE: L3417

11 "LED HEAD LIGHT + LED DAYTIME DRIVING

WARNINGS FOR THE USER:

- Do not look directly into the light - it may cause damage or even loss of vision.
- Install only in specialized workshops or professional services.
- Use in open space only.
- Use in accordance to the purpose.

INSTALLATION INSTRUCTIONS:

- It should be used exclusively in accordance with intended use.
- Mount exclusively in specialized workshops.
- The connection between the lamp and vehicle's installation should be isolated with heat-shrink tube or alternatively with isolating tape to avoid getting water and moisture to the copper wire of the lamp which can damage electronic components. When it comes to lamp and plug, the plug should be mounted safely.
- Do not cut off tinned ends.
- Lamps must be installed only in accordance with UNECE regulations.



PHOTO AND TECHNICAL DRAWING:

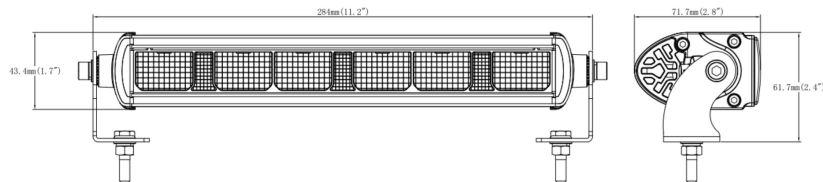

TECHNICAL SPECIFICATIONS:



MATERIAL	LED/LM QUANTITY	MOUNTING	WIRE	FUNCTION	WATT	VOLTAGE	CERTIFICATES	PACKING/WEIGHT
<ul style="list-style-type: none"> » Lens: PC » Housing: AL 	<ul style="list-style-type: none"> » 6 LED » 1570 LM 	<ul style="list-style-type: none"> » screw 	<ul style="list-style-type: none"> » 250mm 	<ul style="list-style-type: none"> » DRL » driving light 	<ul style="list-style-type: none"> » 3W » 20 W 	<ul style="list-style-type: none"> » 12V/24V 	<ul style="list-style-type: none"> » ECE R10 » ECE R148 » ECE R149 	<ul style="list-style-type: none"> » cart. dim.: 370x76x88mm » weight: 500g » 20 pcs/bulk box



REFERENCE: L3418

21" LED HEAD LIGHT + LED DAYTIME DRIVING

WARNINGS FOR THE USER:

- Do not look directly into the light - it may cause damage or even loss of vision.
- Install only in specialized workshops or professional services.
- Use in open space only.
- Use in accordance to the purpose.

INSTALLATION INSTRUCTIONS:

- It should be used exclusively in accordance with intended use.
- Mount exclusively in specialized workshops.
- The connection between the lamp and vehicle's installation should be isolated with heat-shrink tube or alternatively with isolating tape to avoid getting water and moisture to the copper wire of the lamp which can damage electronic components. When it comes to lamp and plug, the plug should be mounted safely.
- Do not cut off tinned ends.
- Lamps must be installed only in accordance with UNECE regulations.



www.myKAMAR.com

PHOTO AND TECHNICAL DRAWING:

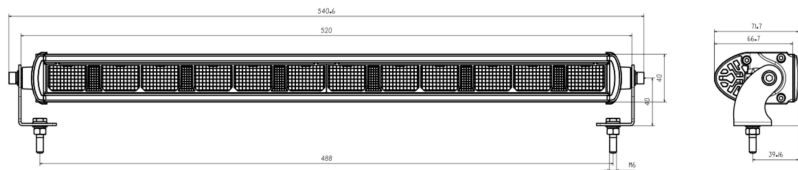

TECHNICAL SPECIFICATIONS:



MATERIAL	LED/LM QUANTITY	MOUNTING	WIRE	FUNCTION	WATT	VOLTAGE	CERTIFICATES	PACKING/WEIGHT
<ul style="list-style-type: none"> » Lens: PC » Housing: AL 	<ul style="list-style-type: none"> » 12 LED » 3340 LM 	<ul style="list-style-type: none"> » screw 	<ul style="list-style-type: none"> » 250mm 	<ul style="list-style-type: none"> » DRL » driving light 	<ul style="list-style-type: none"> » 3W » 47 W 	<ul style="list-style-type: none"> » 12V/24V 	<ul style="list-style-type: none"> » ECE R10 » ECE R148 » ECE R149 	<ul style="list-style-type: none"> » cart. dim.: 605x76x88mm » weight: 1000g » 10 pcs/bulk box

We reserve the right to change technical data and any errors. Photos and specifications are for reference only, and the actual product may vary slightly. Reproduction in whole or parts of the catalog without written authorization is prohibited.



REFERENCE:
L3419

**HEAD LAMP POSITION MIDDLE
FULL LED 12/24V SLIM**

WARNINGS FOR THE USER:

- Do not look directly into the light - it may cause damage or even loss of vision.
- Install only in specialized workshops or professional services.
- Use in open space only.
- Use in accordance to the purpose.

INSTALLATION INSTRUCTIONS:

- It should be used exclusively in accordance with intended use.
- Mount exclusively in specialized workshops.
- The connection between the lamp and vehicle's installation should be isolated with heat-shrink tube or alternatively with isolating tape to avoid getting water and moisture to the copper wire of the lamp which can damage electronic components. When it comes to lamp and plug, the plug should be mounted safely.
- Do not cut off tinned ends.
- Lamps must be installed only in accordance with UNECE regulations.



PHOTO AND TECHNICAL DRAWING:

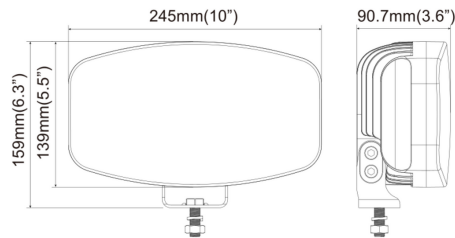

TECHNICAL SPECIFICATIONS:

MATERIAL	LED/LM QUANTITY	MOUNTING	WIRE	FUNCTION	WATT	VOLTAGE	CERTIFICATES	PACKING - BULK BOX
» Lens: PC » Housing: AL	» 10+14 LED » 4000 LM	» screws	» 350 mm	» position light » driving light	» 8W » 50W	» 12V/24V	» ECE R10 » ECE R148 » ECE R149	» cart. dim.: 605x76x88mm » weight: 1000g » 10 pcs/bulk box



REFERENCE: L3420

2XLED 12 24V HEAD LIGHT

WARNINGS FOR THE USER:

- Do not look directly into the light - it may cause damage or even loss of vision.
- Install only in specialized workshops or professional services.
- Use in open space only.
- Use in accordance to the purpose.

INSTALLATION INSTRUCTIONS:

- It should be used exclusively in accordance with intended use.
- Mount exclusively in specialized workshops.
- The connection between the lamp and vehicle's installation should be isolated with heat-shrink tube or alternatively with isolating tape to avoid getting water and moisture to the copper wire of the lamp which can damage electronic components. When it comes to lamp and plug, the plug should be mounted safely.
- Do not cut off tinned ends.
- Lamps must be installed only in accordance with UNECE regulations.



www.myKAMAR.com

PHOTO AND TECHNICAL DRAWING:

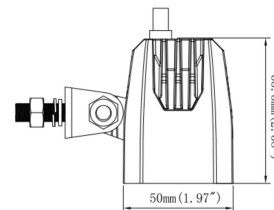
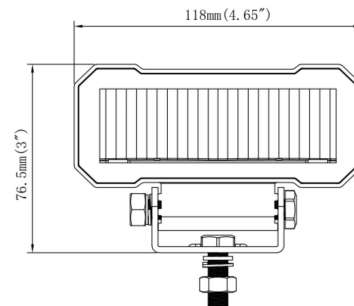

TECHNICAL SPECIFICATIONS:



MATERIAL	LED/LM QUANTITY	MOUNTING	WIRE	FUNCTION	WATT	VOLTAGE	CERTIFICATES	PACKING - BULK BOX
<ul style="list-style-type: none"> » Lens: PC » Housing: AL 	<ul style="list-style-type: none"> » 2 LED » 1750 LM 	<ul style="list-style-type: none"> » screws 	<ul style="list-style-type: none"> » 300 mm 	<ul style="list-style-type: none"> » driving light 	<ul style="list-style-type: none"> » 24W 	<ul style="list-style-type: none"> » 12 V/24V 	<ul style="list-style-type: none"> » ECE R10 » ECE R149 	<ul style="list-style-type: none"> » cart. dim.: 144x128x105mm » weight: 510g » 20 pcs/bulk box

We reserve the right to change technical data and any errors. Photos and specifications are for reference only, and the actual product may vary slightly. Reproduction in whole or parts of the catalog without written authorization is prohibited.



REFERENCE: L3421

LED HEADLIGHT + 1224V LED STRIP POSITION

WARNINGS FOR THE USER:

- Do not look directly into the light - it may cause damage or even loss of vision.
- Install only in specialized workshops or professional services.
- Use in open space only.
- Use in accordance to the purpose.

INSTALLATION INSTRUCTIONS:

- It should be used exclusively in accordance with intended use.
- Mount exclusively in specialized workshops.
- The connection between the lamp and vehicle's installation should be isolated with heat-shrink tube or alternatively with isolating tape to avoid getting water and moisture to the copper wire of the lamp which can damage electronic components. When it comes to lamp and plug, the plug should be mounted safely.
- Do not cut off tinned ends.
- Lamps must be installed only in accordance with UNECE regulations.



PHOTO AND TECHNICAL DRAWING:

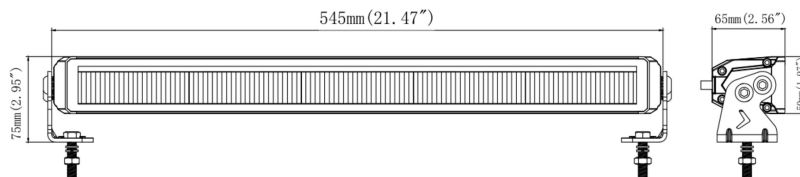

TECHNICAL SPECIFICATIONS:

MATERIAL	LED/LM QUANTITY	MOUNTING	WIRE	FUNCTION	WATT	VOLTAGE	CERTIFICATES	PACKING - BULK BOX
<ul style="list-style-type: none"> » Lens: PC » Housing: AL 	<ul style="list-style-type: none"> » 10x36 LED » 5730 LM » 16 LM 	<ul style="list-style-type: none"> » screws 	<ul style="list-style-type: none"> » 250mm with DT connector 	<ul style="list-style-type: none"> » line position » driving light 	<ul style="list-style-type: none"> » 10W » 65W 	<ul style="list-style-type: none"> » 12V/24V 	<ul style="list-style-type: none"> » ECE R10 » ECE R148 » ECE R149 	<ul style="list-style-type: none"> » cart. dim.: 655x110x88mm » weight: 2260g » 8 pcs/bulk box



REFERENCE: L3422

HEAD LAMP BEZEL-LESS + POSITION

WARNINGS FOR THE USER:

- Do not look directly into the light - it may cause damage or even loss of vision.
- Install only in specialized workshops or professional services.
- Use in open space only.
- Use in accordance to the purpose.

INSTALLATION INSTRUCTIONS:

- It should be used exclusively in accordance with intended use.
- Mount exclusively in specialized workshops.
- The connection between the lamp and vehicle's installation should be isolated with heat-shrink tube or alternatively with isolating tape to avoid getting water and moisture to the copper wire of the lamp which can damage electronic components. When it comes to lamp and plug, the plug should be mounted safely.
- Do not cut off tinned ends.
- Lamps must be installed only in accordance with UNECE regulations.



PHOTO AND TECHNICAL DRAWING:

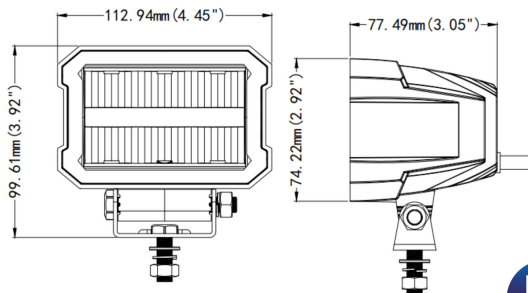

TECHNICAL SPECIFICATIONS:



MATERIAL	LED/LM QUANTITY	MOUNTING	WIRE	FUNCTION	WATT	VOLTAGE	CERTIFICATES	PACKING/WEIGHT
» Lens: PC » Housing: AL	» 6+6 LED » 2200 LM	» screw	» 300 mm	» line position » driving light	» 3W » 25W	» 12 V/24V	» ECE R10 » ECE R148 » ECE E149	» cart. dim.: 142x155x114mm » weight: 530g » 20 pcs/bulk box

We reserve the right to change technical data and any errors. Photos and specifications are for reference only, and the actual product may vary slightly. Reproduction in whole or parts of the catalog without written authorization is prohibited.



REFERENCE: L3423

LED HEADLIGHT BEZEL-LESS + 1224V LED + STRIP POSITION

WARNINGS FOR THE USER:

- Do not look directly into the light - it may cause damage or even loss of vision.
- Install only in specialized workshops or professional services.
- Use in open space only.
- Use in accordance to the purpose.

INSTALLATION INSTRUCTIONS:

- It should be used exclusively in accordance with intended use.
- Mount exclusively in specialized workshops.
- The connection between the lamp and vehicle's installation should be isolated with heat-shrink tube or alternatively with isolating tape to avoid getting water and moisture to the copper wire of the lamp which can damage electronic components. When it comes to lamp and plug, the plug should be mounted safely.
- Do not cut off tinned ends.
- Lamps must be installed only in accordance with UNECE regulations.



ZDJĘCIE I RYSUNEK TECHNICZNY:

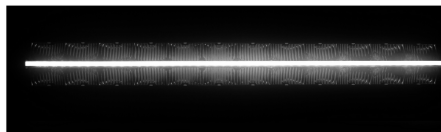
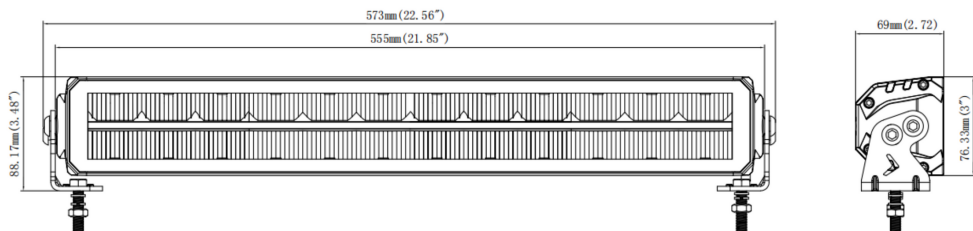

SPECYFIKACJA TECHNICZNA:



MATERIAL	LED/LM QUANTITY	MOUNTING	WIRE	FUNCTION	WATT	VOLTAGE	CERTIFICATES	PACKING - BULK BOX
<ul style="list-style-type: none"> » Lens: PC » Housing: AL 	<ul style="list-style-type: none"> » 24 + 48LED » 7927 LM 	<ul style="list-style-type: none"> » screws 	<ul style="list-style-type: none"> » 300mm with DT connector 	<ul style="list-style-type: none"> » line position » driving light 	<ul style="list-style-type: none"> » 1W » 95W 	<ul style="list-style-type: none"> » 12V/24V 	<ul style="list-style-type: none"> » ECE R10 » ECE R148 » ECE R149 	<ul style="list-style-type: none"> » cart. dim.: 657x111x93mm » weight: 2000g » 4 pcs/bulk box

myKAMAR



REFERENCE:
L3424

LED HEADLIGHT + 12/24V LED STRIP POSITION

WARNINGS FOR THE USER:

- Do not look directly into the light - it may cause damage or even loss of vision.
- Install only in specialized workshops or professional services.
- Use in open space only.
- Use in accordance to the purpose.

INSTALLATION INSTRUCTIONS:

- It should be used exclusively in accordance with intended use.
- Mount exclusively in specialized workshops.
- The connection between the lamp and vehicle's installation should be isolated with heat-shrink tube or alternatively with isolating tape to avoid getting water and moisture to the copper wire of the lamp which can damage electronic components. When it comes to lamp and plug, the plug should be mounted safely.
- Do not cut off tinned ends.
- Lamps must be installed only in accordance with UNECE regulations.



www.myKAMAR.com

PHOTO AND TECHNICAL DRAWING:

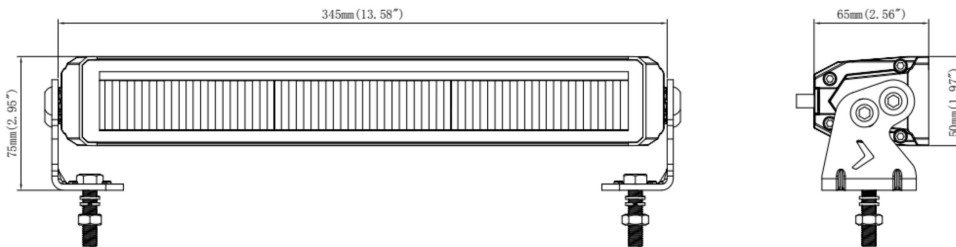

TECHNICAL SPECIFICATIONS:

MATERIAL	LED/LM QUANTITY	MOUNTING	WIRE	FUNCTION	WATT	VOLTAGE	CERTIFICATES	PACKING - BULK BOX
» Lens: PC » Housing: AL	» 6+21 LED » 3810 LM » 10 LM	» screw	» 300mm with DT connector	» position » driving light	» 8W » 42W	» 12V/24V	» ECE R10 » ECE R148 » ECE R149	» cart. dim.: 462x110x88mm » weight: 1600g » 8 pcs/bulk box

We reserve the right to change technical data and any errors. Photos and specifications are for reference only, and the actual product may vary slightly. Reproduction in whole or parts of the catalog without written authorization is prohibited.

myKAMAR



REFERENCE:
L3425

HEAD LAMP BEZEL-LESS MEDIUM

12/24V LED

WARNINGS FOR THE USER:

- Do not look directly into the light - it may cause damage or even loss of vision.
- Install only in specialized workshops or professional services.
- Use in open space only.
- Use in accordance to the purpose.

INSTALLATION INSTRUCTIONS:

- It should be used exclusively in accordance with intended use.
- Mount exclusively in specialized workshops.
- The connection between the lamp and vehicle's installation should be isolated with heat-shrink tube or alternatively with isolating tape to avoid getting water and moisture to the copper wire of the lamp which can damage electronic components. When it comes to lamp and plug, the plug should be mounted safely.
- Do not cut off tinned ends.
- Lamps must be installed only in accordance with UNECE regulations.



www.myKAMAR.com

PHOTO AND TECHNICAL DRAWING:

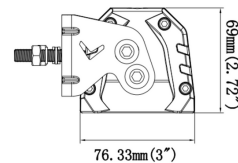
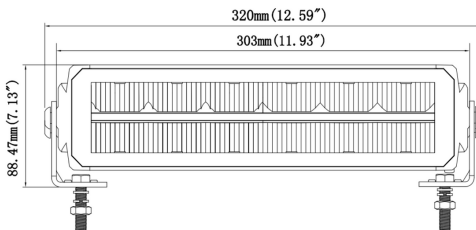
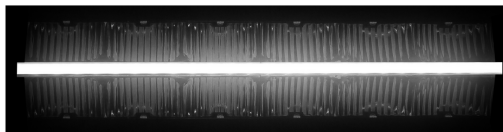

TECHNICAL SPECIFICATIONS:

MATERIAL	LED/LM QUANTITY	MOUNTING	WIRE	FUNCTION	WATT	VOLTAGE	CERTIFICATES	PACKING - BULK BOX
<ul style="list-style-type: none"> » Lens: PC » Housing: AL 	<ul style="list-style-type: none"> » 12+24 LED » 4708 LM 	<ul style="list-style-type: none"> » screw 	<ul style="list-style-type: none"> » 250mm with DT connector 	<ul style="list-style-type: none"> » position » driving light 	<ul style="list-style-type: none"> » 4,5W » 45W 	<ul style="list-style-type: none"> » 12V/24V 	<ul style="list-style-type: none"> » ECE R10 » ECE R148 » ECE R149 	<ul style="list-style-type: none"> » cart. dim.: 400x110x95mm » weight: 1400g » 8 pcs/bulk box



We reserve the right to change technical data and any errors. Photos and specifications are for reference only, and the actual product may vary slightly. Reproduction in whole or parts of the catalog without written authorization is prohibited.



REFERENCE: L3426

HEADLIGHT LED + POSITION LIGHT + STROBO AMBER

WARNINGS FOR THE USER:

- Do not look directly into the light - it may cause damage or even loss of vision.
- Install only in specialized workshops or professional services.
- Use in open space only.
- Use in accordance to the purpose.

INSTALLATION INSTRUCTIONS:

- It should be used exclusively in accordance with intended use.
- Mount exclusively in specialized workshops.
- The connection between the lamp and vehicle's installation should be isolated with heat-shrink tube or alternatively with isolating tape to avoid getting water and moisture to the copper wire of the lamp which can damage electronic components. When it comes to lamp and plug, the plug should be mounted safely.
- Do not cut off tinned ends.
- Lamps must be installed only in accordance with UNECE regulations.



PHOTO AND TECHNICAL DRAWING:

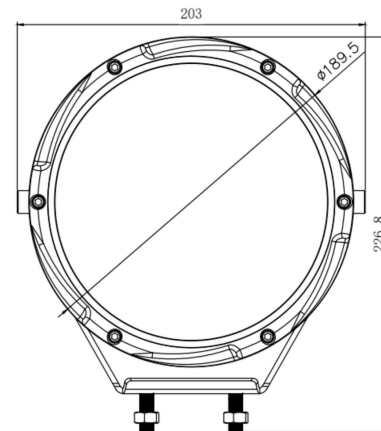
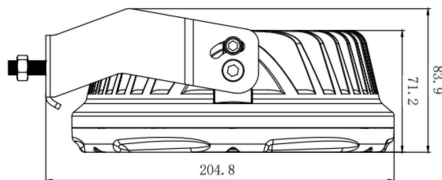
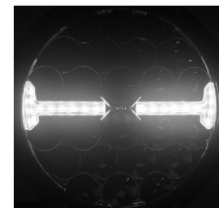
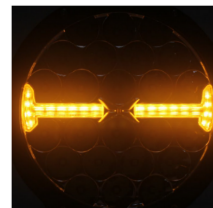

TECHNICAL SPECIFICATIONS:



MATERIAL	LED/LM QUANTITY	MOUNTING	WIRE	FUNCTION	WATT	VOLTAGE	CERTIFICATES	PACKING - BULK BOX
» Lens: PC » Housing: AL	» 24+20+20 LED » 10920 LM	» screw	» 250mm with DT connector	» position » driving light » warning lamp	» 4,5W » 100W » 4,5W	» 12V/24V	» ECE R10 » ECE R65 » ECE R148 » ECE R149	» cart. dim.: 240x220x103mm » weight: 1000g » 4 pcs/bulk box



REFERENCE:
L3427

HEAD LAMP LED + POSITION LED
12/24V

WARNINGS FOR THE USER:

- Do not look directly into the light - it may cause damage or even loss of vision.
- Install only in specialized workshops or professional services.
- Use in open space only.
- Use in accordance to the purpose.

INSTALLATION INSTRUCTIONS:

- It should be used exclusively in accordance with intended use.
- Mount exclusively in specialized workshops.
- The connection between the lamp and vehicle's installation should be isolated with heat-shrink tube or alternatively with isolating tape to avoid getting water and moisture to the copper wire of the lamp which can damage electronic components. When it comes to lamp and plug, the plug should be mounted safely.
- Do not cut off tinned ends.
- Lamps must be installed only in accordance with UNECE regulations.

PHOTO AND TECHNICAL DRAWING:

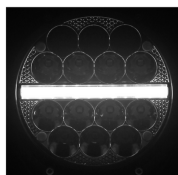
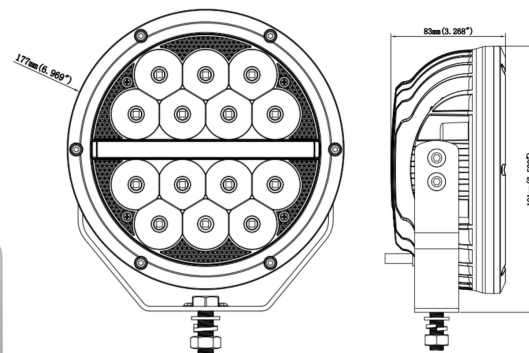

COVER INCLUDED



TECHNICAL SPECIFICATIONS:

MATERIAL	LED/LM QUANTITY	MOUNTING	WIRE	FUNCTION	WATT	VOLTAGE	CERTIFICATES	PACKING - BULK BOX
» Lens: PC » Housing: AL	» 14+12 LED » 5960 LM	» screw	» 250mm	» driving light » line position	» 2W » 52W	» 12V/24V	» ECE R10 » ECE R148 » ECE R149	» cart. dim.: 263x217x141mm » weight: 1500g » 6 pcs/bulk box

We reserve the right to change technical data and any errors. Photos and specifications are for reference only, and the actual product may vary slightly. Reproduction in whole or parts of the catalog without written authorization is prohibited.





REFERENCE:
L3430

HEAD LAMP LED R148 R149 LEFT

WARNINGS FOR THE USER:

- Do not look directly into the light - it may cause damage or even loss of vision.
- Install only in specialized workshops or professional services.
- Use in open space only.
- Use in accordance to the purpose.

INSTALLATION INSTRUCTIONS:

- It should be used exclusively in accordance with intended use.
- Mount exclusively in specialized workshops.
- The connection between the lamp and vehicle's installation should be isolated with heat-shrink tube or alternatively with isolating tape to avoid getting water and moisture to the copper wire of the lamp which can damage electronic components. When it comes to lamp and plug, the plug should be mounted safely.
- Do not cut off tinned ends.
- Lamps must be installed only in accordance with UNECE regulations.



PHOTO AND TECHNICAL DRAWING:

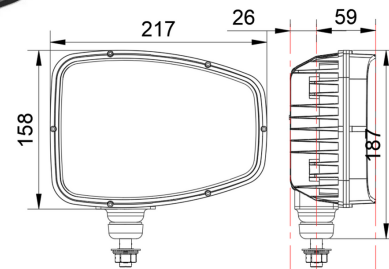

TECHNICAL SPECIFICATIONS:

MATERIAL	LED/LM QUANTITY	MOUNTING	WIRE	FUNCTION	WATT	VOLTAGE	CERTIFICATES	PACKING - BULK BOX
<ul style="list-style-type: none"> » Lens: PC » Housing: AL 	<ul style="list-style-type: none"> » 19 LED 	<ul style="list-style-type: none"> » screw 	<ul style="list-style-type: none"> » socket in the lamp » wire 20cm with plug 	<ul style="list-style-type: none"> » position » low beam » high beam » DRL » indicator 	<ul style="list-style-type: none"> » 4W » 15W » 25W » 12W » 6W 	<ul style="list-style-type: none"> » 12V/24V 	<ul style="list-style-type: none"> » ECE R10 » ECE R148 » ECE R149 	<ul style="list-style-type: none"> » cart. dim.: 263x217x141mm » weight: 1500g » 10 pcs/bulk box

We reserve the right to change technical data and any errors. Photos and specifications are for reference only, and the actual product may vary slightly. Reproduction in whole or parts of the catalog without written authorization is prohibited.



REFERENCE:
L3431

HEAD LAMP LED R148 R149 RIGHT

WARNINGS FOR THE USER:

- Do not look directly into the light - it may cause damage or even loss of vision.
- Install only in specialized workshops or professional services.
- Use in open space only.
- Use in accordance to the purpose.

INSTALLATION INSTRUCTIONS:

- It should be used exclusively in accordance with intended use.
- Mount exclusively in specialized workshops.
- The connection between the lamp and vehicle's installation should be isolated with heat-shrink tube or alternatively with isolating tape to avoid getting water and moisture to the copper wire of the lamp which can damage electronic components. When it comes to lamp and plug, the plug should be mounted safely.
- Do not cut off tinned ends.
- Lamps must be installed only in accordance with UNECE regulations.



PHOTO AND TECHNICAL DRAWING:

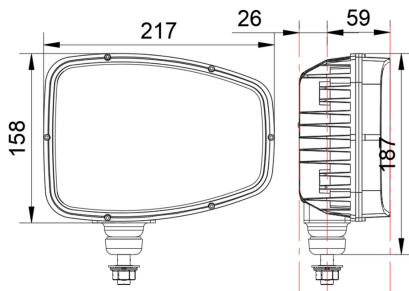

TECHNICAL SPECIFICATIONS:

MATERIAL	LED/LM QUANTITY	MOUNTING	WIRE	FUNCTION	WATT	VOLTAGE	CERTIFICATES	PACKING - BULK BOX
<ul style="list-style-type: none"> » Lens: PC » Housing: AL 	<ul style="list-style-type: none"> » 19 LED 	<ul style="list-style-type: none"> » screw 	<ul style="list-style-type: none"> » socket in the lamp » wire 20cm with plug 	<ul style="list-style-type: none"> » position » low beam » high beam » DRL » indicator 	<ul style="list-style-type: none"> » 4W » 15W » 25W » 12W » 6W 	<ul style="list-style-type: none"> » 12V/24V 	<ul style="list-style-type: none"> » ECE R10 » ECE R148 » ECE R149 	<ul style="list-style-type: none"> » cart. dim.: 263x217x141mm » weight: 1500g » 10 pcs/bulk box

We reserve the right to change technical data and any errors. Photos and specifications are for reference only, and the actual product may vary slightly. Reproduction in whole or parts of the catalog without written authorization is prohibited.

KAMAR S.K.A.

Al. Armii Krajowej 254
85-689 Bydgoszcz
Polska

NIP 554-039-23-83
REGON 093051226

tel: / +48 / 52 326 71 50
fax: / +48 / 52 326 71 58
info@mykamar.com