

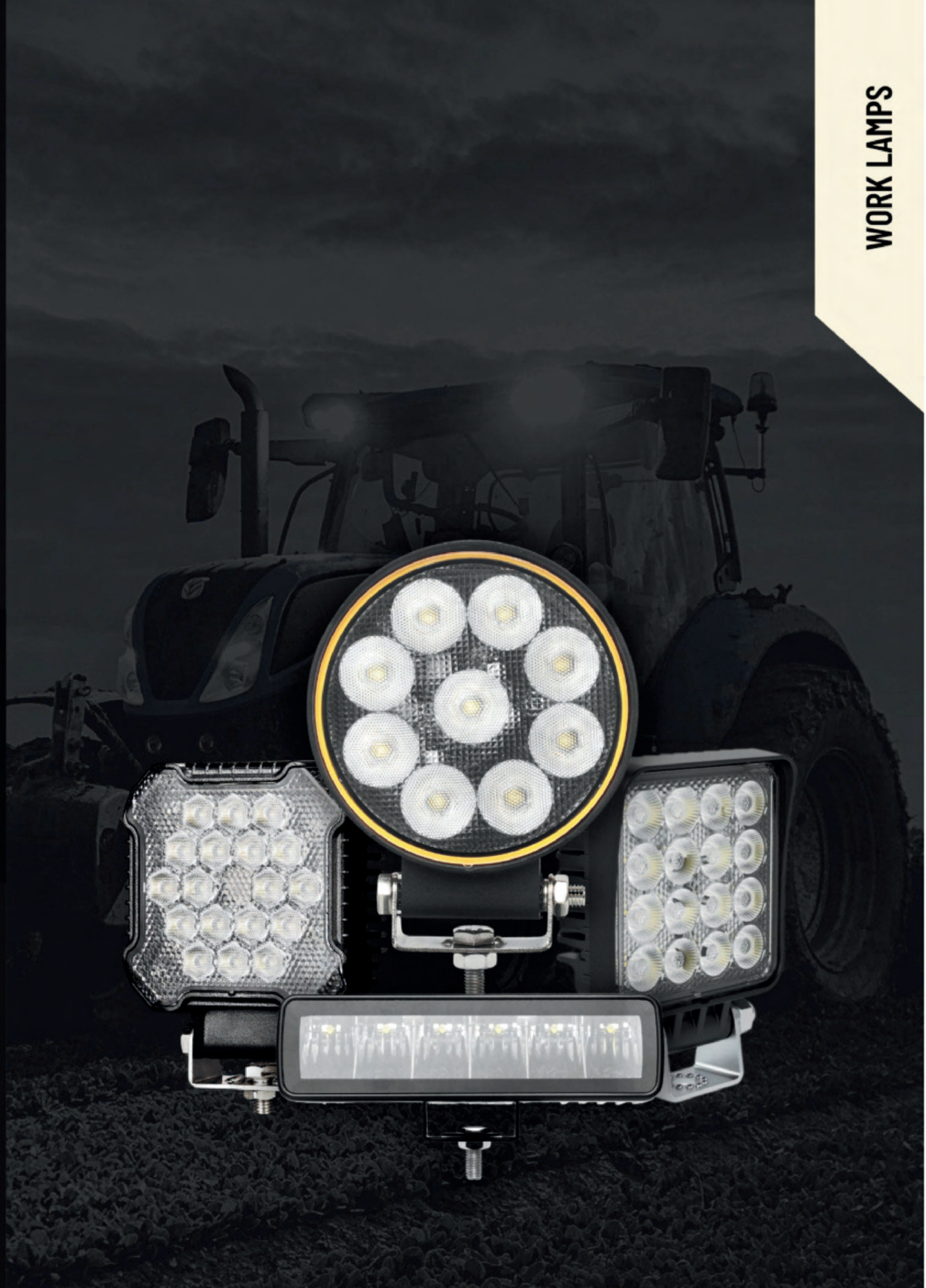

WORK LAMPS & LED PANELS

WORK LAMPS





REFERENCE:
L0061

**LED WORKING LAMP CUBE - 2
PCS SET**

WARNINGS FOR THE USER:

- Do not look directly into the light - it may cause damage or even loss of vision.
- Install only in specialized workshops or professional services.
- Use in open space only.
- Use in accordance to the purpose.

INSTALLATION INSTRUCTIONS:

- It should be used exclusively in accordance with intended use.
- Mount exclusively in specialized workshops.
- The connection between the lamp and vehicle's installation should be isolated with heat-shrink tube or alternatively with isolating tape to avoid getting water and moisture to the copper wire of the lamp which can damage electronic components. When it comes to lamp and plug, the plug should be mounted safely.
- Do not cut off tinned ends.
- Lamps must be installed only in accordance with UNECE regulations.



www.myKAMAR.com

PHOTO AND TECHNICAL DRAWING:

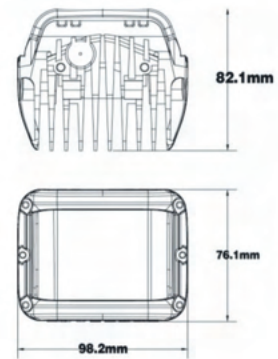

TECHNICAL SPECIFICATIONS:

MATERIAL	LED/LM QUANTITY	MOUNTING	WIRE	FUNCTION	WATT	VOLTAGE	CERTIFICATES	PACKING/WEIGHT
• Lens: PC • Housing: AL	• 9 LED • 2762 LM	• screw	• 250mm	• work light • combo	• 45W	• 12V/24V	• ECE R10	• cart. dim.: 186x170x108mm • weight: 700g • 20 sets/40pcs/bulk box

We reserve the right to change technical data and any errors. Photos and specifications are for reference only, and the actual product may vary slightly. Reproduction in whole or parts of the catalog without written authorization is prohibited.



REFERENCE:
L0064

WORK LAMP LED CUBE

WARNINGS FOR THE USER:

- Do not look directly into the light - it may cause damage or even loss of vision.
- Install only in specialized workshops or professional services.
- Use in open space only.
- Use in accordance to the purpose.

INSTALLATION INSTRUCTIONS:

- It should be used exclusively in accordance with intended use.
- Mount exclusively in specialized workshops.
- The connection between the lamp and vehicle's installation should be isolated with heat-shrink tube or alternatively with isolating tape to avoid getting water and moisture to the copper wire of the lamp which can damage electronic components. When it comes to lamp and plug, the plug should be mounted safely.
- Do not cut off tinned ends.
- Lamps must be installed only in accordance with UNECE regulations.



www.myKAMAR.com

PHOTO AND TECHNICAL DRAWING:

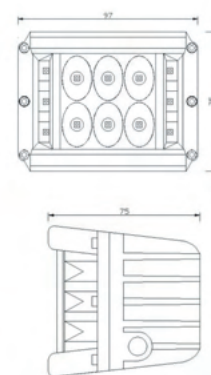

TECHNICAL SPECIFICATIONS:

MATERIAL	LED/LM QUANTITY	MOUNTING	WIRE	FUNCTION	WATT	VOLTAGE	CERTIFICATES	PACKING/WEIGHT
• Lens: PC • Housing: AL	• 12 LED • 1440 LM	• screw	• 300mm	• work light • flood	• 15,6W	• 12V/24V	• ECE R10	• cart. dim.: 100x90x90mm • weight: 418g • 40 pcs/bulk box

We reserve the right to change technical data and any errors. Photos and specifications are for reference only, and the actual product may vary slightly. Reproduction in whole or parts of the catalog without written authorization is prohibited.



REFERENCE:
L0068

WORK LAMP 5X 3W LED MINI

WARNINGS FOR THE USER:

- Do not look directly into the light - it may cause damage or even loss of vision.
- Install only in specialized workshops or professional services.
- Use in open space only.
- Use in accordance to the purpose.

INSTALLATION INSTRUCTIONS:

- It should be used exclusively in accordance with intended use.
- Mount exclusively in specialized workshops.
- The connection between the lamp and vehicle's installation should be isolated with heat-shrink tube or alternatively with isolating tape to avoid getting water and moisture to the copper wire of the lamp which can damage electronic components. When it comes to lamp and plug, the plug should be mounted safely.
- Do not cut off tinned ends.
- Lamps must be installed only in accordance with UNECE regulations.



www.myKAMAR.com

PHOTO AND TECHNICAL DRAWING:

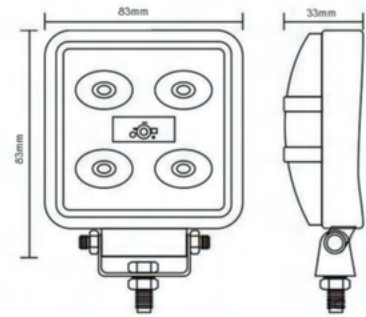

TECHNICAL SPECIFICATIONS:



MATERIAL	LED/LM QUANTITY	MOUNTING	WIRE	FUNCTION	WATT	VOLTAGE	CERTIFICATES	PACKING/WEIGHT
• Lens: PC • Housing: AL	• 5 LED • 630 LM	• screw	• 300mm	• work light • flood	• 12W	• 12V/24V	• ECE R10	• cart. dim.: 96x56x120mm • weight: 216g • 36 pcs/bulk box

We reserve the right to change technical data and any errors. Photos and specifications are for reference only, and the actual product may vary slightly. Reproduction in whole or parts of the catalog without written authorization is prohibited.



REFERENCE:
L0068-2M

**LED WORK LAMP FLOOD WITH
2M CABLE**

WARNINGS FOR THE USER:

- Do not look directly into the light - it may cause damage or even loss of vision.
- Install only in specialized workshops or professional services.
- Use in open space only.
- Use in accordance to the purpose.

INSTALLATION INSTRUCTIONS:

- It should be used exclusively in accordance with intended use.
- Mount exclusively in specialized workshops.
- The connection between the lamp and vehicle's installation should be isolated with heat-shrink tube or alternatively with isolating tape to avoid getting water and moisture to the copper wire of the lamp which can damage electronic components. When it comes to lamp and plug, the plug should be mounted safely.
- Do not cut off tinned ends.
- Lamps must be installed only in accordance with UNECE regulations.



www.myKAMAR.com

PHOTO AND TECHNICAL DRAWING:

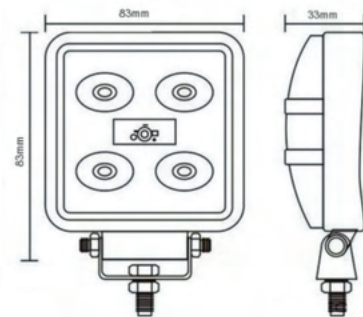

TECHNICAL SPECIFICATIONS:



MATERIAL	LED/LM QUANTITY	MOUNTING	WIRE	FUNCTION	WATT	VOLTAGE	CERTIFICATES	PACKING/WEIGHT
• Lens: PC • Housing: AL	• 5 LED • 630 LM	• screw	• 2000mm	• work light • flood	• 12W	• 12V/24V	• ECE R10	• cart. dim.: 96x56x120mm • weight: 274g • 36 pcs/bulk box

We reserve the right to change technical data and any errors. Photos and specifications are for reference only, and the actual product may vary slightly. Reproduction in whole or parts of the catalog without written authorization is prohibited.



REFERENCE:
L0074-B

LED WORK LAMP ROUND 4X LED

WARNINGS FOR THE USER:

- Do not look directly into the light - it may cause damage or even loss of vision.
- Install only in specialized workshops or professional services.
- Use in open space only.
- Use in accordance to the purpose.

INSTALLATION INSTRUCTIONS:

- It should be used exclusively in accordance with intended use.
- Mount exclusively in specialized workshops.
- The connection between the lamp and vehicle's installation should be isolated with heat-shrink tube or alternatively with isolating tape to avoid getting water and moisture to the copper wire of the lamp which can damage electronic components. When it comes to lamp and plug, the plug should be mounted safely.
- Do not cut off tinned ends.
- Lamps must be installed only in accordance with UNECE regulations.



www.myKAMAR.com

PHOTO AND TECHNICAL DRAWING:

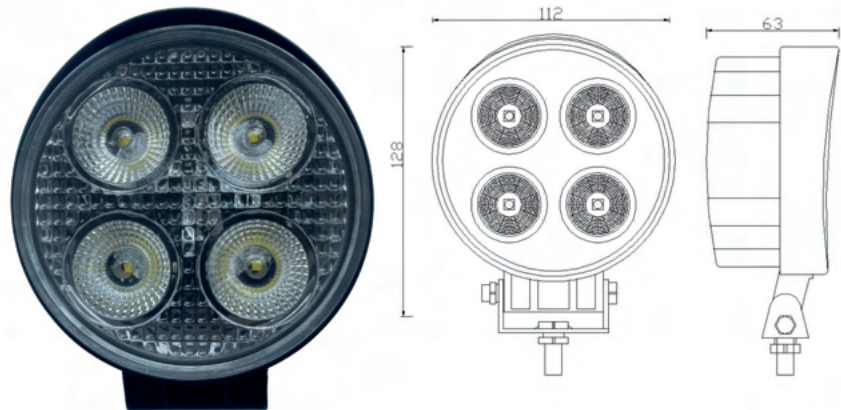

TECHNICAL SPECIFICATIONS:



MATERIAL	LED/LM QUANTITY	MOUNTING	WIRE	FUNCTION	WATT	VOLTAGE	CERTIFICATES	PACKING/WEIGHT
• Lens: PC • Housing: AL	• 18 LED • 1200 LM	• screw	• 300mm	• work light • spot	• 16,4W	• 12V/24V	• ECE R10	• cart. dim.: 55x45x200mm • weight: 190g • 50 pcs/bulk box

We reserve the right to change technical data and any errors. Photos and specifications are for reference only, and the actual product may vary slightly. Reproduction in whole or parts of the catalog without written authorization is prohibited.



REFERENCE:
L0075-B

LED WORK LAMP LED 4X SQUARE

WARNINGS FOR THE USER:

- Do not look directly into the light - it may cause damage or even loss of vision.
- Install only in specialized workshops or professional services.
- Use in open space only.
- Use in accordance to the purpose.

INSTALLATION INSTRUCTIONS:

- It should be used exclusively in accordance with intended use.
- Mount exclusively in specialized workshops.
- The connection between the lamp and vehicle's installation should be isolated with heat-shrink tube or alternatively with isolating tape to avoid getting water and moisture to the copper wire of the lamp which can damage electronic components. When it comes to lamp and plug, the plug should be mounted safely.
- Do not cut off tinned ends.
- Lamps must be installed only in accordance with UNECE regulations.

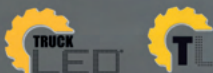

www.myKAMAR.com

PHOTO AND TECHNICAL DRAWING:

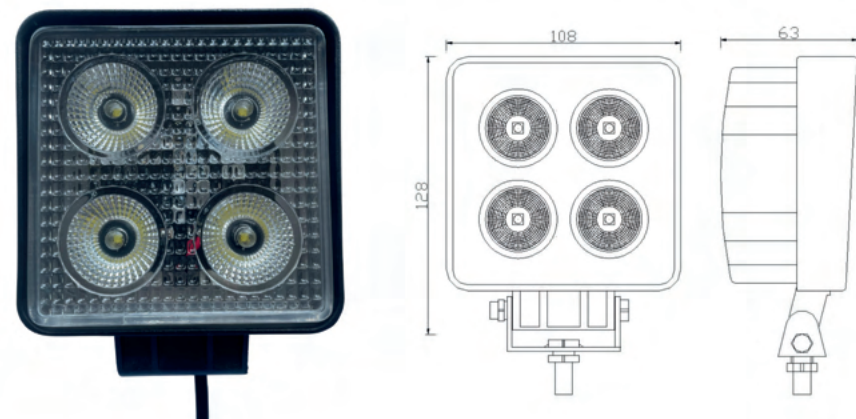

TECHNICAL SPECIFICATIONS:



MATERIAL	LED/LM QUANTITY	MOUNTING	WIRE	FUNCTION	WATT	VOLTAGE	CERTIFICATES	PACKING/WEIGHT
• Lens: PC • Housing: AL	• 24 LED • 1800 LM	• screw	• 300mm	• work light • spot	• 23W	• 12V/24V	• ECE R10	• cart. dim.: 55x45x200mm • weight: 300g • 50 pcs/bulk box

We reserve the right to change technical data and any errors. Photos and specifications are for reference only, and the actual product may vary slightly. Reproduction in whole or parts of the catalog without written authorization is prohibited.



REFERENCE:
L0076

LED WORK LAMP LED 9X ROUND

WARNINGS FOR THE USER:

- Do not look directly into the light - it may cause damage or even loss of vision.
- Install only in specialized workshops or professional services.
- Use in open space only.
- Use in accordance to the purpose.

INSTALLATION INSTRUCTIONS:

- It should be used exclusively in accordance with intended use.
- Mount exclusively in specialized workshops.
- The connection between the lamp and vehicle's installation should be isolated with heat-shrink tube or alternatively with isolating tape to avoid getting water and moisture to the copper wire of the lamp which can damage electronic components. When it comes to lamp and plug, the plug should be mounted safely.
- Do not cut off tinned ends.
- Lamps must be installed only in accordance with UNECE regulations.



www.myKAMAR.com

PHOTO AND TECHNICAL DRAWING:

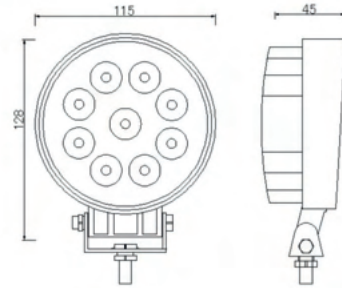

TECHNICAL SPECIFICATIONS:



MATERIAL	LED/LM QUANTITY	MOUNTING	WIRE	FUNCTION	WATT	VOLTAGE	CERTIFICATES	PACKING/WEIGHT
• Lens: PC • Housing: AL	• 9 LED • 1430 LM	• screw	• 4000mm	• work light • flood	• 24W	• 12V/24V	• ECE R10	• cart. dim.: 119x65x148mm • weight: 500g • 20 pcs/bulk box

We reserve the right to change technical data and any errors. Photos and specifications are for reference only, and the actual product may vary slightly. Reproduction in whole or parts of the catalog without written authorization is prohibited.



REFERENCE:
L0076S

LED WORK LAMP LED 9X LED ROUND

WARNINGS FOR THE USER:

- Do not look directly into the light - it may cause damage or even loss of vision.
- Install only in specialized workshops or professional services.
- Use in open space only.
- Use in accordance to the purpose.

INSTALLATION INSTRUCTIONS:

- It should be used exclusively in accordance with intended use.
- Mount exclusively in specialized workshops.
- The connection between the lamp and vehicle's installation should be isolated with heat-shrink tube or alternatively with isolating tape to avoid getting water and moisture to the copper wire of the lamp which can damage electronic components. When it comes to lamp and plug, the plug should be mounted safely.
- Do not cut off tinned ends.
- Lamps must be installed only in accordance with UNECE regulations.

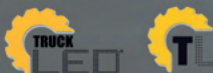

www.myKAMAR.com

PHOTO AND TECHNICAL DRAWING:

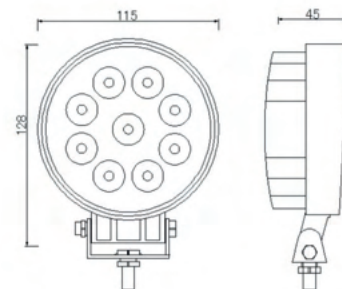

TECHNICAL SPECIFICATIONS:



MATERIAL	LED/LM QUANTITY	MOUNTING	WIRE	FUNCTION	WATT	VOLTAGE	CERTIFICATES	PACKING/WEIGHT
• Lens: PC • Housing: AL	• 9 LED • 1430 LM	• screw	• 300mm	• work light • spot	• 24W	• 12V/24V	• ECE R10	• cart. dim.: 119x65x148mm • weight: 317g • 20 pcs/bulk box

We reserve the right to change technical data and any errors. Photos and specifications are for reference only, and the actual product may vary slightly. Reproduction in whole or parts of the catalog without written authorization is prohibited.



REFERENCE:
L0077

LED WORK LAMP 9X LED SQUARE

WARNINGS FOR THE USER:

- Do not look directly into the light - it may cause damage or even loss of vision.
- Install only in specialized workshops or professional services.
- Use in open space only.
- Use in accordance to the purpose.

INSTALLATION INSTRUCTIONS:

- It should be used exclusively in accordance with intended use.
- Mount exclusively in specialized workshops.
- The connection between the lamp and vehicle's installation should be isolated with heat-shrink tube or alternatively with isolating tape to avoid getting water and moisture to the copper wire of the lamp which can damage electronic components. When it comes to lamp and plug, the plug should be mounted safely.
- Do not cut off tinned ends.
- Lamps must be installed only in accordance with UNECE regulations.



www.myKAMAR.com

PHOTO:

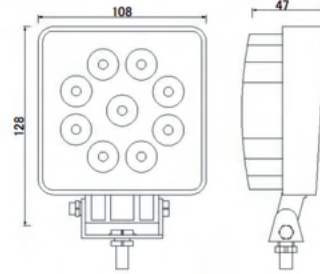

TECHNICAL SPECIFICATIONS:



MATERIAL	LED/LM QUANTITY	MOUNTING	WIRE	FUNCTION	WATT	VOLTAGE	CERTIFICATES	PACKING/WEIGHT
• Lens: PC • Housing: AL	• 9 LED • 1430 LM	• screw	• 4000mm	• work light • flood	• 24W	• 12V/24V	• ECE R10	• cart. dim.: 119x65x148mm • weight: 317g • 20 pcs/bulk box

We reserve the right to change technical data and any errors. Photos and specifications are for reference only, and the actual product may vary slightly. Reproduction in whole or parts of the catalog without written authorization is prohibited.



REFERENCE:
L0077-4M

**LED WORK LAMP LED SQUARE 9X
CABLE 4M**

WARNINGS FOR THE USER:

- Do not look directly into the light - it may cause damage or even loss of vision.
- Install only in specialized workshops or professional services.
- Use in open space only.
- Use in accordance to the purpose.

INSTALLATION INSTRUCTIONS:

- It should be used exclusively in accordance with intended use.
- Mount exclusively in specialized workshops.
- The connection between the lamp and vehicle's installation should be isolated with heat-shrink tube or alternatively with isolating tape to avoid getting water and moisture to the copper wire of the lamp which can damage electronic components. When it comes to lamp and plug, the plug should be mounted safely.
- Do not cut off tinned ends.
- Lamps must be installed only in accordance with UNECE regulations.



www.myKAMAR.com

PHOTO:

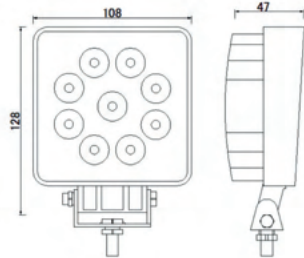

TECHNICAL SPECIFICATIONS:



MATERIAL	LED/LM QUANTITY	MOUNTING	WIRE	FUNCTION	WATT	VOLTAGE	CERTIFICATES	PACKING/WEIGHT
• Lens: PC • Housing: AL	• 9 LED • 1430 LM	• screw	• 4000mm	• work light • flood	• 24W	• 12V/24V	• ECE R10	• cart. dim.: 119x65x148mm • weight: 317g • 20 pcs/bulk box

We reserve the right to change technical data and any errors. Photos and specifications are for reference only, and the actual product may vary slightly. Reproduction in whole or parts of the catalog without written authorization is prohibited.



**REFERENCE:
L0077-7M**

**LED WORK LAMP 9X LED WITH 7M
CABLE**

WARNINGS FOR THE USER:

- Do not look directly into the light - it may cause damage or even loss of vision.
- Install only in specialized workshops or professional services.
- Use in open space only.
- Use in accordance to the purpose.

INSTALLATION INSTRUCTIONS:

- It should be used exclusively in accordance with intended use.
- Mount exclusively in specialized workshops.
- The connection between the lamp and vehicle's installation should be isolated with heat-shrink tube or alternatively with isolating tape to avoid getting water and moisture to the copper wire of the lamp which can damage electronic components. When it comes to lamp and plug, the plug should be mounted safely.
- Do not cut off tinned ends.
- Lamps must be installed only in accordance with UNECE regulations.



www.myKAMAR.com

PHOTO:

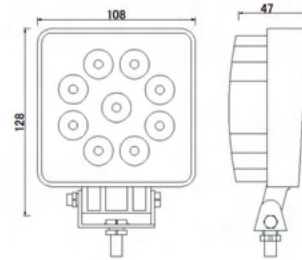

TECHNICAL SPECIFICATIONS:



MATERIAL	LED/LM QUANTITY	MOUNTING	WIRE	FUNCTION	WATT	VOLTAGE	CERTIFICATES	PACKING/WEIGHT
• Lens: PC • Housing: AL	• 9 LED • 1430 LM	• screw	• 7000mm	• work light • flood	• 24W	• 12V/24V	• ECE R10	• cart. dim.: 119x65x148mm • weight: 317g • 20 pcs/bulk box

We reserve the right to change technical data and any errors. Photos and specifications are for reference only, and the actual product may vary slightly. Reproduction in whole or parts of the catalog without written authorization is prohibited.



**REFERENCE:
L0078-B**

LED WORK LAMP SMALL FLOOD

WARNINGS FOR THE USER:

- Do not look directly into the light - it may cause damage or even loss of vision.
- Install only in specialized workshops or professional services.
- Use in open space only.
- Use in accordance to the purpose.

INSTALLATION INSTRUCTIONS:

- It should be used exclusively in accordance with intended use.
- Mount exclusively in specialized workshops.
- The connection between the lamp and vehicle's installation should be isolated with heat-shrink tube or alternatively with isolating tape to avoid getting water and moisture to the copper wire of the lamp which can damage electronic components. When it comes to lamp and plug, the plug should be mounted safely.
- Do not cut off tinned ends.
- Lamps must be installed only in accordance with UNECE regulations.



www.myKAMAR.com

PHOTO AND TECHNICAL DRAWING:

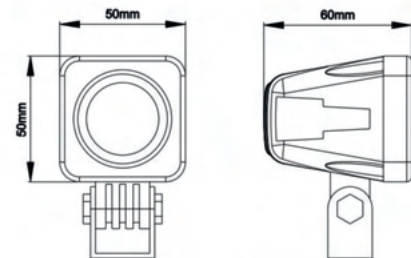

TECHNICAL SPECIFICATIONS:



MATERIAL	LED/LM QUANTITY	MOUNTING	WIRE	FUNCTION	WATT	VOLTAGE	CERTIFICATES	PACKING/WEIGHT
• Lens: PC • Housing: AL	• 1 LED • 805 LM	• screw	• 300 mm	• work light • flood	• 4W	• 12V/24V	• ECE R10	• cart. dim.: 100x90x90mm • weight: 330g • 50 pcs/bulk box

We reserve the right to change technical data and any errors. Photos and specifications are for reference only, and the actual product may vary slightly. Reproduction in whole or parts of the catalog without written authorization is prohibited.



**REFERENCE:
L0081**

**LED WORK LAMP 16X LED
SQUARE**

WARNINGS FOR THE USER:

- Do not look directly into the light - it may cause damage or even loss of vision.
- Install only in specialized workshops or professional services.
- Use in open space only.
- Use in accordance to the purpose.

INSTALLATION INSTRUCTIONS:

- It should be used exclusively in accordance with intended use.
- Mount exclusively in specialized workshops.
- The connection between the lamp and vehicle's installation should be isolated with heat-shrink tube or alternatively with isolating tape to avoid getting water and moisture to the copper wire of the lamp which can damage electronic components. When it comes to lamp and plug, the plug should be mounted safely.
- Do not cut off tinned ends.
- Lamps must be installed only in accordance with UNECE regulations.



www.myKAMAR.com

PHOTO AND TECHNICAL DRAWING:

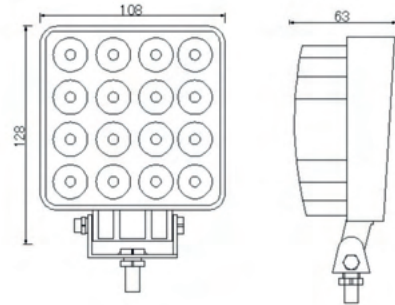

TECHNICAL SPECIFICATIONS:



MATERIAL	LED/LM QUANTITY	MOUNTING	WIRE	FUNCTION	WATT	VOLTAGE	CERTIFICATES	PACKING/WEIGHT
• Lens: PC • Housing: AL	• 16 LED • 2100 LM	• screw	• 4000 mm	• work light • flood	• 43W	• 12V/24V	• ECE R10	• cart. dim.: 119x65x148mm • weight: 484g • 20 pcs/bulk box

We reserve the right to change technical data and any errors. Photos and specifications are for reference only, and the actual product may vary slightly. Reproduction in whole or parts of the catalog without written authorization is prohibited.



**REFERENCE:
L0081-B**

**LED WORK LAMP 16X LED
SQUARE**

WARNINGS FOR THE USER:

- Do not look directly into the light - it may cause damage or even loss of vision.
- Install only in specialized workshops or professional services.
- Use in open space only.
- Use in accordance to the purpose.

INSTALLATION INSTRUCTIONS:

- It should be used exclusively in accordance with intended use.
- Mount exclusively in specialized workshops.
- The connection between the lamp and vehicle's installation should be isolated with heat-shrink tube or alternatively with isolating tape to avoid getting water and moisture to the copper wire of the lamp which can damage electronic components. When it comes to lamp and plug, the plug should be mounted safely.
- Do not cut off tinned ends.
- Lamps must be installed only in accordance with UNECE regulations.



www.myKAMAR.com

PHOTO AND TECHNICAL DRAWING:

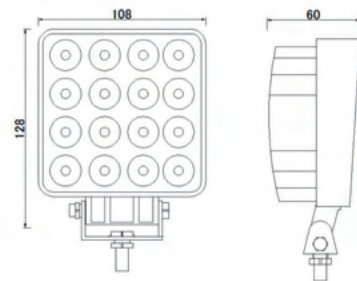

TECHNICAL SPECIFICATIONS:



MATERIAL	LED/LM QUANTITY	MOUNTING	WIRE	FUNCTION	WATT	VOLTAGE	CERTIFICATES	PACKING/WEIGHT
• Lens: PC • Housing: AL	• 16 LED • 2100 LM	• screw	• 300 mm	• work light	• 24W	• 12V/24V	• ECE R10	• cart. dim.: 119x65x148mm • weight: 402g • 20 pcs/bulk box

We reserve the right to change technical data and any errors. Photos and specifications are for reference only, and the actual product may vary slightly. Reproduction in whole or parts of the catalog without written authorization is prohibited.



REFERENCE:
L0081S

**LED WORK LAMP 16X LED
SQUARE SPOT**

WARNINGS FOR THE USER:

- Do not look directly into the light - it may cause damage or even loss of vision.
- Install only in specialized workshops or professional services.
- Use in open space only.
- Use in accordance to the purpose.

INSTALLATION INSTRUCTIONS:

- It should be used exclusively in accordance with intended use.
- Mount exclusively in specialized workshops.
- The connection between the lamp and vehicle's installation should be isolated with heat-shrink tube or alternatively with isolating tape to avoid getting water and moisture to the copper wire of the lamp which can damage electronic components. When it comes to lamp and plug, the plug should be mounted safely.
- Do not cut off tinned ends.
- Lamps must be installed only in accordance with UNECE regulations.



www.myKAMAR.com

PHOTO AND TECHNICAL DRAWING:

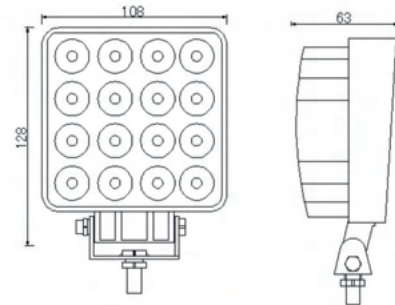

TECHNICAL SPECIFICATIONS:



MATERIAL	LED/LM QUANTITY	MOUNTING	WIRE	FUNCTION	WATT	VOLTAGE	CERTIFICATES	PACKING/WEIGHT
• Lens: PC • Housing: AL	• 16 LED • 2100 LM	• screw	• 300 mm	• work light • spot	• 43W	• 12V/24V	• ECE R10	• cart. dim.: 119x65x148mm • weight: 484g • 20 pcs/bulk box

We reserve the right to change technical data and any errors. Photos and specifications are for reference only, and the actual product may vary slightly. Reproduction in whole or parts of the catalog without written authorization is prohibited.



REFERENCE:
L0082

LED WORK LAMP LED 4X

WARNINGS FOR THE USER:

- Do not look directly into the light - it may cause damage or even loss of vision.
- Install only in specialized workshops or professional services.
- Use in open space only.
- Use in accordance to the purpose.

INSTALLATION INSTRUCTIONS:

- It should be used exclusively in accordance with intended use.
- Mount exclusively in specialized workshops.
- The connection between the lamp and vehicle's installation should be isolated with heat-shrink tube or alternatively with isolating tape to avoid getting water and moisture to the copper wire of the lamp which can damage electronic components. When it comes to lamp and plug, the plug should be mounted safely.
- Do not cut off tinned ends.
- Lamps must be installed only in accordance with UNECE regulations.

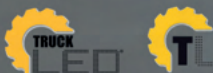

www.myKAMAR.com

PHOTO AND TECHNICAL DRAWING:

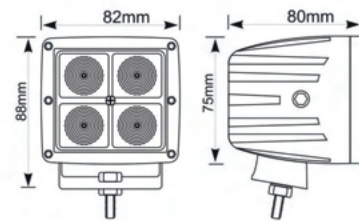

TECHNICAL SPECIFICATIONS:



MATERIAL	LED/LM QUANTITY	MOUNTING	WIRE	FUNCTION	WATT	VOLTAGE	CERTIFICATES	PACKING/WEIGHT
• Lens: PC • Housing: AL	• 4 LED • 1000 LM	• screw	• 250 mm	• work light • flood	• 18W	• 12V/24V	• ECE R10	• cart. dim.: 140x100x90mm • weight: 450g • 20 pcs/bulk box

We reserve the right to change technical data and any errors. Photos and specifications are for reference only, and the actual product may vary slightly. Reproduction in whole or parts of the catalog without written authorization is prohibited.



REFERENCE:
L0089

LED WORK LAMP 15X LED

WARNINGS FOR THE USER:

- Do not look directly into the light - it may cause damage or even loss of vision.
- Install only in specialized workshops or professional services.
- Use in open space only.
- Use in accordance to the purpose.

INSTALLATION INSTRUCTIONS:

- It should be used exclusively in accordance with intended use.
- Mount exclusively in specialized workshops.
- The connection between the lamp and vehicle's installation should be isolated with heat-shrink tube or alternatively with isolating tape to avoid getting water and moisture to the copper wire of the lamp which can damage electronic components. When it comes to lamp and plug, the plug should be mounted safely.
- Do not cut off tinned ends.
- Lamps must be installed only in accordance with UNECE regulations.



www.myKAMAR.com

PHOTO AND TECHNICAL DRAWING:

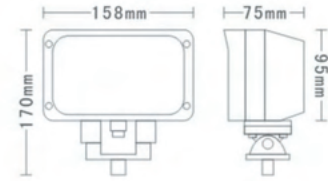

TECHNICAL SPECIFICATIONS:



MATERIAL	LED/LM QUANTITY	MOUNTING	WIRE	FUNCTION	WATT	VOLTAGE	CERTIFICATES	PACKING/WEIGHT
• Lens: PMMA • Housing: AL	• 15 LED • 1720 LM	• screw	• 300 mm	• work light • flood	• 26W	• 12V/24V	• ECE R10	• cart. dim.: 170x130x100mm • weight: 910g • 20 pcs/bulk box

We reserve the right to change technical data and any errors. Photos and specifications are for reference only, and the actual product may vary slightly. Reproduction in whole or parts of the catalog without written authorization is prohibited.



REFERENCE:
L0091

LED WORK LAMP 17X LED RED ROUND

WARNINGS FOR THE USER:

- Do not look directly into the light - it may cause damage or even loss of vision.
- Install only in specialized workshops or professional services.
- Use in open space only.
- Use in accordance to the purpose.

INSTALLATION INSTRUCTIONS:

- It should be used exclusively in accordance with intended use.
- Mount exclusively in specialized workshops.
- The connection between the lamp and vehicle's installation should be isolated with heat-shrink tube or alternatively with isolating tape to avoid getting water and moisture to the copper wire of the lamp which can damage electronic components. When it comes to lamp and plug, the plug should be mounted safely.
- Do not cut off tinned ends.
- Lamps must be installed only in accordance with UNECE regulations.



www.myKAMAR.com

PHOTO AND TECHNICAL DRAWING:

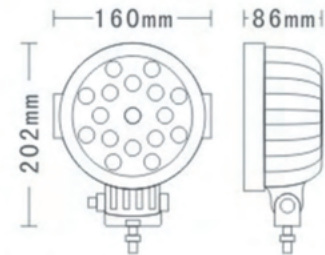

TECHNICAL SPECIFICATIONS:



MATERIAL	LED/LM QUANTITY	MOUNTING	WIRE	FUNCTION	WATT	VOLTAGE	CERTIFICATES	PACKING/WEIGHT
• Lens: PC • Housing: AL	• 17 LED	• screw	• 300 mm	• work light	• 31.33W	• 12V/24V	• ECE R10	• cart. dim.: 190x180x115mm • weight: 2000g • 12 pcs/bulk box

We reserve the right to change technical data and any errors. Photos and specifications are for reference only, and the actual product may vary slightly. Reproduction in whole or parts of the catalog without written authorization is prohibited.



REFERENCE:
L0091-B

**LED WORK LAMP 17X LED ROUND
BLACK**

WARNINGS FOR THE USER:

- Do not look directly into the light - it may cause damage or even loss of vision.
- Install only in specialized workshops or professional services.
- Use in open space only.
- Use in accordance to the purpose.

INSTALLATION INSTRUCTIONS:

- It should be used exclusively in accordance with intended use.
- Mount exclusively in specialized workshops.
- The connection between the lamp and vehicle's installation should be isolated with heat-shrink tube or alternatively with isolating tape to avoid getting water and moisture to the copper wire of the lamp which can damage electronic components. When it comes to lamp and plug, the plug should be mounted safely.
- Do not cut off tinned ends.
- Lamps must be installed only in accordance with UNECE regulations.



www.myKAMAR.com

PHOTO AND TECHNICAL DRAWING:

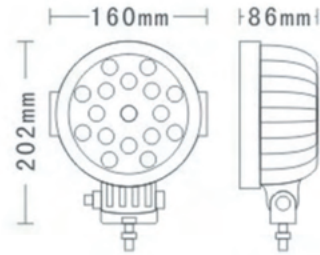

TECHNICAL SPECIFICATIONS:



MATERIAL	LED/LM QUANTITY	MOUNTING	WIRE	FUNCTION	WATT	VOLTAGE	CERTIFICATES	PACKING/WEIGHT
• Lens: PC • Housing: AL	• 17	• screw	• 300 mm	• work light	• 31-33W	• 12V/24V	• ECE R10	• cart. dim.: 190x180x115mm • weight: 2000g • 12 pcs/bulk box

We reserve the right to change technical data and any errors. Photos and specifications are for reference only, and the actual product may vary slightly. Reproduction in whole or parts of the catalog without written authorization is prohibited.



REFERENCE:
L0094-1

LED WORK LAMP 4X LED SPOT

WARNINGS FOR THE USER:

- Do not look directly into the light - it may cause damage or even loss of vision.
- Install only in specialized workshops or professional services.
- Use in open space only.
- Use in accordance to the purpose.

INSTALLATION INSTRUCTIONS:

- It should be used exclusively in accordance with intended use.
- Mount exclusively in specialized workshops.
- The connection between the lamp and vehicle's installation should be isolated with heat-shrink tube or alternatively with isolating tape to avoid getting water and moisture to the copper wire of the lamp which can damage electronic components. When it comes to lamp and plug, the plug should be mounted safely.
- Do not cut off tinned ends.
- Lamps must be installed only in accordance with UNECE regulations.

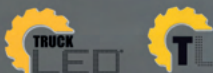

www.myKAMAR.com

PHOTO AND TECHNICAL DRAWING:

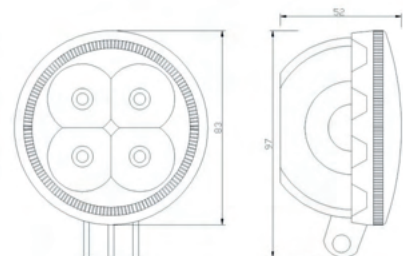

TECHNICAL SPECIFICATIONS:



MATERIAL	LED/LM QUANTITY	MOUNTING	WIRE	FUNCTION	WATT	VOLTAGE	CERTIFICATES	PACKING/WEIGHT
• Lens: PC • Housing: AL	• 4 LED • 700LM	• screw	• 300 mm	• work light • spot	• 14W	• 12V/24V	• ECE R10	• cart. dim.: 90x100x90mm • weight: 110g • 40 pcs/bulk box

We reserve the right to change technical data and any errors. Photos and specifications are for reference only, and the actual product may vary slightly. Reproduction in whole or parts of the catalog without written authorization is prohibited.



REFERENCE:
L0094F-1

LED WORK LAMP 4X LED FLOOD

WARNINGS FOR THE USER:

- Do not look directly into the light - it may cause damage or even loss of vision.
- Install only in specialized workshops or professional services.
- Use in open space only.
- Use in accordance to the purpose.

INSTALLATION INSTRUCTIONS:

- It should be used exclusively in accordance with intended use.
- Mount exclusively in specialized workshops.
- The connection between the lamp and vehicle's installation should be isolated with heat-shrink tube or alternatively with isolating tape to avoid getting water and moisture to the copper wire of the lamp which can damage electronic components. When it comes to lamp and plug, the plug should be mounted safely.
- Do not cut off tinned ends.
- Lamps must be installed only in accordance with UNECE regulations.



www.myKAMAR.com

PHOTO AND TECHNICAL DRAWING:

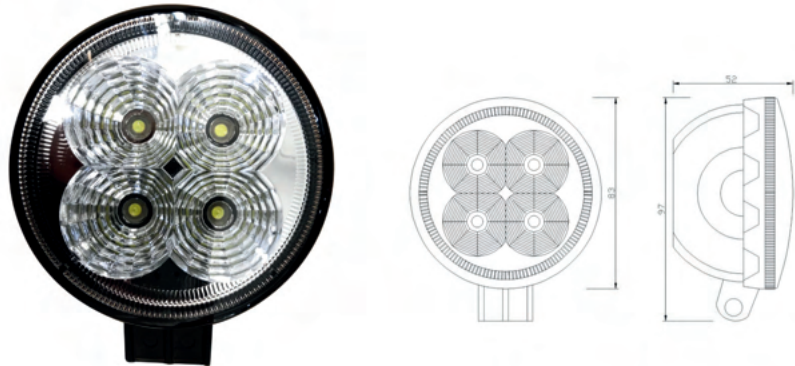

TECHNICAL SPECIFICATIONS:

MATERIAL	LED/LM QUANTITY	MOUNTING	WIRE	FUNCTION	WATT	VOLTAGE	CERTIFICATES	PACKING/WEIGHT
• Lens: PC • Housing: AL	• 4 LED • 700LM	• screw	• 300 mm	• work light • flood	• 14W	• 12V/24V	• ECE R10	• cart. dim.: 90x100x90mm • weight: 119g • 40 pcs/bulk box

We reserve the right to change technical data and any errors. Photos and specifications are for reference only, and the actual product may vary slightly. Reproduction in whole or parts of the catalog without written authorization is prohibited.



REFERENCE:
L0097-B

LED WORK LAMP LED 6X FLOOD

WARNINGS FOR THE USER:

- Do not look directly into the light - it may cause damage or even loss of vision.
- Install only in specialized workshops or professional services.
- Use in open space only.
- Use in accordance to the purpose.

INSTALLATION INSTRUCTIONS:

- It should be used exclusively in accordance with intended use.
- Mount exclusively in specialized workshops.
- The connection between the lamp and vehicle's installation should be isolated with heat-shrink tube or alternatively with isolating tape to avoid getting water and moisture to the copper wire of the lamp which can damage electronic components. When it comes to lamp and plug, the plug should be mounted safely.
- Do not cut off tinned ends.
- Lamps must be installed only in accordance with UNECE regulations.

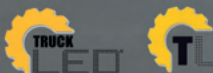

www.myKAMAR.com

PHOTO AND TECHNICAL DRAWING:



TECHNICAL SPECIFICATIONS:

MATERIAL	LED/LM QUANTITY	MOUNTING	WIRE	FUNCTION	WATT	VOLTAGE	CERTIFICATES	PACKING/WEIGHT
• Lens: PC • Housing: AL	• 6 LED • 1680 LM	• screw	• 300 mm	• work light • flood	• 15.2W	• 12V/24V	• ECE R10	• cart. dim.: 92x62x170mm • weight: 240g • 50 pcs/bulk box

We reserve the right to change technical data and any errors. Photos and specifications are for reference only, and the actual product may vary slightly. Reproduction in whole or parts of the catalog without written authorization is prohibited.



REFERENCE:
L0097S-B

WORK LAMP LED 6X LED SPOT

WARNINGS FOR THE USER:

- Do not look directly into the light - it may cause damage or even loss of vision.
- Install only in specialized workshops or professional services.
- Use in open space only.
- Use in accordance to the purpose.

INSTALLATION INSTRUCTIONS:

- It should be used exclusively in accordance with intended use.
- Mount exclusively in specialized workshops.
- The connection between the lamp and vehicle's installation should be isolated with heat-shrink tube or alternatively with isolating tape to avoid getting water and moisture to the copper wire of the lamp which can damage electronic components. When it comes to lamp and plug, the plug should be mounted safely.
- Do not cut off tinned ends.
- Lamps must be installed only in accordance with UNECE regulations.



www.myKAMAR.com

PHOTO AND TECHNICAL DRAWING:

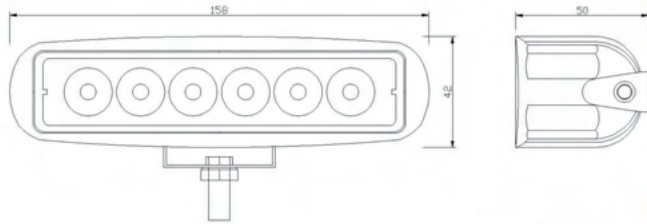
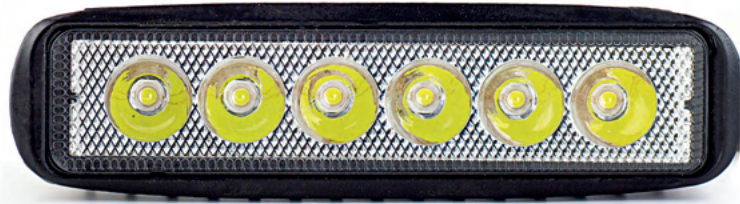

TECHNICAL SPECIFICATIONS:

MATERIAL	LED/LM QUANTITY	MOUNTING	WIRE	FUNCTION	WATT	VOLTAGE	CERTIFICATES	PACKING/WEIGHT
• Lens: PC • Housing: AL	• 6 LED • 1680 LM	• screw	• 300 mm	• work light • spot	• 15.2W	• 12V/24V	• ECE R10	• cart. dim.: 92x52x170mm • weight: 240g • 50 pcs/bulk box

We reserve the right to change technical data and any errors. Photos and specifications are for reference only, and the actual product may vary slightly. Reproduction in whole or parts of the catalog without written authorization is prohibited.



REFERENCE:
L0099

LED WORK LAMP LED RECTANGULAR 6X

WARNINGS FOR THE USER:

- Do not look directly into the light - it may cause damage or even loss of vision.
- Install only in specialized workshops or professional services.
- Use in open space only.
- Use in accordance to the purpose.

INSTALLATION INSTRUCTIONS:

- It should be used exclusively in accordance with intended use.
- Mount exclusively in specialized workshops.
- The connection between the lamp and vehicle's installation should be isolated with heat-shrink tube, or alternatively, with isolating tape, to avoid getting water and moisture to the copper wire of the lamp, which can damage electronic components. When it comes to lamp and plug, the plug should be mounted safely.
- Do not cut off tinned ends.
- Lamps must be installed only in accordance with UNECE regulations
- Only mount the lamp to a flat, metal, dry, cleaned and degreased roof surface. The maximum speed of movement of the vehicle with a warning lamp attached with a magnet to the roof surface is 50km/h. Take special care in windy conditions. Do not unscrew the lamp, it will lose its water resistance.

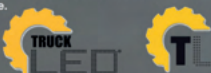

www.myKAMAR.com

PHOTO AND TECHNICAL DRAWING:

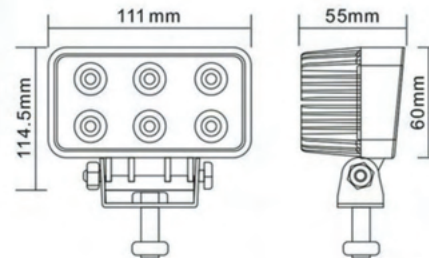

TECHNICAL SPECIFICATIONS:

MATERIAL	LED/LM QUANTITY	MOUNTING	WIRE	FUNCTION	WATT	VOLTAGE	CERTIFICATES	PACKING - BULK BOX
• Lens: PC • Housing: AL	• 6 LED • 1100 LM	• screws	• 250 mm	• work light • flood	• 14.9W	• 12 V/24V	• ECE R10	• cart. dim.: 119x55x148mm • weight: 450g • 20 pcs/bulk box

We reserve the right to change technical data and any errors. Photos and specifications are for reference only, and the actual product may vary slightly. Reproduction in whole or parts of the catalog without written authorization is prohibited.



**REFERENCE:
L0102-1-B**

**LED WORK LAMP 14X LED
ROUND**

WARNINGS FOR THE USER:

- Do not look directly into the light - it may cause damage or even loss of vision.
- Install only in specialized workshops or professional services.
- Use in open space only.
- Use in accordance to the purpose.

INSTALLATION INSTRUCTIONS:

- It should be used exclusively in accordance with intended use.
- Mount exclusively in specialized workshops.
- The connection between the lamp and vehicle's installation should be isolated with heat shrink tube, or, alternatively, with isolating tape, to avoid getting water and moisture to the copper wire of the lamp, which can damage electronic components. When it comes to lamp and plug, the plug should be mounted safely.
- Do not cut off tinned ends.
- Lamps must be installed only in accordance with UNECE regulations
- Only mount the lamp to a flat, metal, dry, cleaned and degreased roof surface. The maximum speed of movement of the vehicle with a warning lamp attached with a magnet to the roof surface is 50km/h. Take special care in windy conditions. Do not unscrew the lamp, it will lose its water resistance.



www.myKAMAR.com

PHOTO AND TECHNICAL DRAWING:

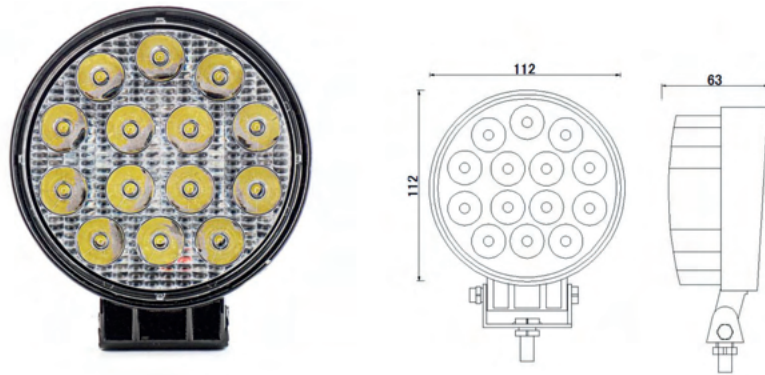

TECHNICAL SPECIFICATIONS:

MATERIAL	LED/LM QUANTITY	MOUNTING	WIRE	FUNCTION	WATT	VOLTAGE	CERTIFICATES	PACKING - BULK BOX
• Lens: PC • Housing: AL	• 14 LED • 2100 LM	• screw	• 300 mm	• work light • flood	• 40W	• 12 V/24V	• ECE R10	• cart. dim.: 110x65x148mm • weight: 449g • 20 pcs/bulk box

We reserve the right to change technical data and any errors. Photos and specifications are for reference only, and the actual product may vary slightly. Reproduction in whole or parts of the catalog without written authorization is prohibited.



**REFERENCE:
L0105-B**

LED WORK LAMP 4XLED

WARNINGS FOR THE USER:

- Do not look directly into the light - it may cause damage or even loss of vision.
- Install only in specialized workshops or professional services.
- Use in open space only.
- Use in accordance to the purpose.

INSTALLATION INSTRUCTIONS:

- It should be used exclusively in accordance with intended use.
- Mount exclusively in specialized workshops.
- The connection between the lamp and vehicle's installation should be isolated with heat shrink tube or alternatively with isolating tape to avoid getting water and moisture to the copper wire of the lamp which can damage electronic components. When it comes to lamp and plug, the plug should be mounted safely.
- Do not cut off tinned ends.
- Lamps must be installed only in accordance with UNECE regulations.



www.myKAMAR.com

PHOTO AND TECHNICAL DRAWING:

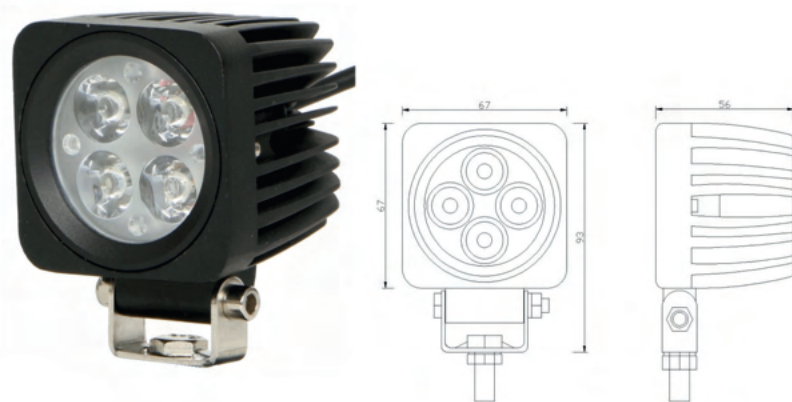

TECHNICAL SPECIFICATIONS:

MATERIAL	LED/LM QUANTITY	MOUNTING	WIRE	FUNCTION	WATT	VOLTAGE	CERTIFICATES	PACKING - BULK BOX
• Lens: PC • Housing: AL	• 4 LED • 420 LM	• screws	• 300 mm	• work light • flood	• 6W	• 12 V/24V	• ECE R10	• cart. dim.: 92x80x66mm • weight: 400g • 60 pcs/bulk box

We reserve the right to change technical data and any errors. Photos and specifications are for reference only, and the actual product may vary slightly. Reproduction in whole or parts of the catalog without written authorization is prohibited.



REFERENCE:
L0109-B

WORK LAMP LED ELIPSA 8 X LED

WARNINGS FOR THE USER:

- Do not look directly into the light - it may cause damage or even loss of vision.
- Install only in specialized workshops or professional services.
- Use in open space only.
- Use in accordance to the purpose.

INSTALLATION INSTRUCTIONS:

- It should be used exclusively in accordance with intended use.
- Mount exclusively in specialized workshops.
- The connection between the lamp and vehicle's installation should be isolated with heat-shrink tube or alternatively with isolating tape to avoid getting water and moisture to the copper wire of the lamp which can damage electronic components. When it comes to lamp and plug, the plug should be mounted safely.
- Do not cut off tinned ends.
- Lamps must be installed only in accordance with UNECE regulations.



www.myKAMAR.com

PHOTO AND TECHNICAL DRAWING:

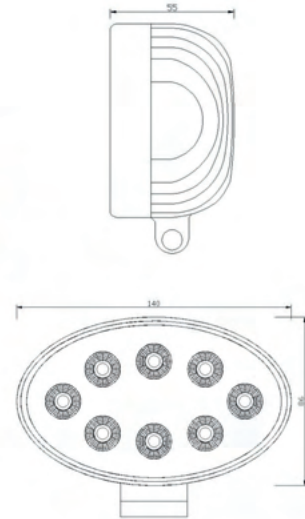

TECHNICAL SPECIFICATIONS:

MATERIAL	LED/LM QUANTITY	MOUNTING	WIRE	FUNCTION	WATT	VOLTAGE	CERTIFICATES	PACKING - BULK BOX
• Lens: PC • Housing: AL	• 8 LED • 1920 LM	• screws	• 300 mm	• work light • flood	• 24W	• 12 V/24V	• ECE R10	• cart. dim.: 110x65x148mm • weight: 287g • 20 pcs/bulk box

We reserve the right to change technical data and any errors. Photos and specifications are for reference only, and the actual product may vary slightly. Reproduction in whole or parts of the catalog without written authorization is prohibited.



REFERENCE:
L0112-B

LED WORK LAMP ROUND SMALL FLOOD

WARNINGS FOR THE USER:

- Do not look directly into the light - it may cause damage or even loss of vision.
- Install only in specialized workshops or professional services.
- Use in open space only.
- Use in accordance to the purpose.

INSTALLATION INSTRUCTIONS:

- It should be used exclusively in accordance with intended use.
- Mount exclusively in specialized workshops.
- The connection between the lamp and vehicle's installation should be isolated with heat-shrink tube or alternatively with isolating tape to avoid getting water and moisture to the copper wire of the lamp which can damage electronic components. When it comes to lamp and plug, the plug should be mounted safely.
- Do not cut off tinned ends.
- Lamps must be installed only in accordance with UNECE regulations.



www.myKAMAR.com

PHOTO AND TECHNICAL DRAWING:

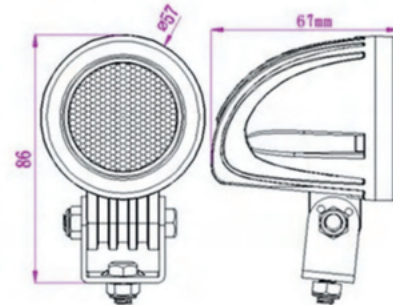

TECHNICAL SPECIFICATIONS:

MATERIAL	LED/LM QUANTITY	MOUNTING	WIRE	FUNCTION	WATT	VOLTAGE	CERTIFICATES	PACKING - BULK BOX
• Lens: PC • Housing: AL	• 1 LED • 900 LM	• screws	• 300 mm	• work light • flood	• 10W	• 12 V/24V	• ECE R10	• cart. dim.: 100x90x90mm • weight: 197g • 40 pcs/bulk box

We reserve the right to change technical data and any errors. Photos and specifications are for reference only, and the actual product may vary slightly. Reproduction in whole or parts of the catalog without written authorization is prohibited.



REFERENCE:
L0119

LED WORK LAMP 4X LED

WARNINGS FOR THE USER:

- Do not look directly into the light - it may cause damage or even loss of vision.
- Install only in specialized workshops or professional services.
- Use in open space only.
- Use in accordance to the purpose.

INSTALLATION INSTRUCTIONS:

- It should be used exclusively in accordance with intended use.
- Mount exclusively in specialized workshops.
- The connection between the lamp and vehicle's installation should be isolated with heat-shrink tube or alternatively with isolating tape to avoid getting water and moisture to the copper wire of the lamp which can damage electronic components. When it comes to lamp and plug, the plug should be mounted safely.
- Do not cut off tinned ends.
- Lamps must be installed only in accordance with UNECE regulations.



www.myKAMAR.com

PHOTO AND TECHNICAL DRAWING:

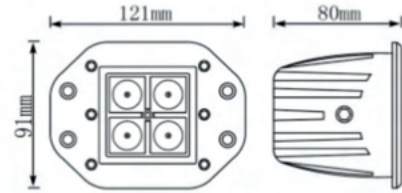

TECHNICAL SPECIFICATIONS:

MATERIAL	LED/LM QUANTITY	MOUNTING	WIRE	FUNCTION	WATT	VOLTAGE	CERTIFICATES	PACKING - BULK BOX
• Lens: PC • Housing: AL	• 4 LED • 496 LM	• screws	• 300 mm	• work light • flood	• 6W	• 12 V/24V	• ECE R10	• cart. dim.: 140x105x105mm • weight: 510g • 30 pcs/bulk box

We reserve the right to change technical data and any errors. Photos and specifications are for reference only, and the actual product may vary slightly. Reproduction in whole or parts of the catalog without written authorization is prohibited.



REFERENCE:
L0123

LED WORK LAMP 3XLED FLOOD

WARNINGS FOR THE USER:

- Do not look directly into the light - it may cause damage or even loss of vision.
- Install only in specialized workshops or professional services.
- Use in open space only.
- Use in accordance to the purpose.

INSTALLATION INSTRUCTIONS:

- It should be used exclusively in accordance with intended use.
- Mount exclusively in specialized workshops.
- The connection between the lamp and vehicle's installation should be isolated with heat-shrink tube or alternatively with isolating tape to avoid getting water and moisture to the copper wire of the lamp which can damage electronic components. When it comes to lamp and plug, the plug should be mounted safely.
- Do not cut off tinned ends.
- Lamps must be installed only in accordance with UNECE regulations.

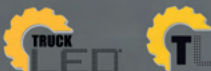

www.myKAMAR.com

PHOTO AND TECHNICAL DRAWING:

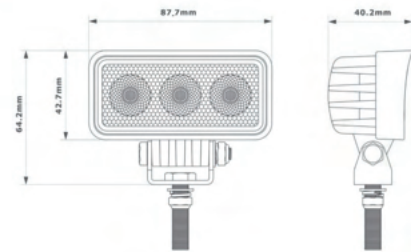

TECHNICAL SPECIFICATIONS:

MATERIAL	LED/LM QUANTITY	MOUNTING	WIRE	FUNCTION	WATT	VOLTAGE	CERTIFICATES	PACKING - BULK BOX
• Lens: PC • Housing: AL	• 3 LED • 664 LM	• screws	• 500 mm	• work light • flood	• 7.1W	• 12 V/24V	• ECE R10	• cart. dim.: 100x90x60mm • weight: 235g • 40 pcs/bulk box

We reserve the right to change technical data and any errors. Photos and specifications are for reference only, and the actual product may vary slightly. Reproduction in whole or parts of the catalog without written authorization is prohibited.



**REFERENCE:
L0124**

LED WORK LAMP 8XLED FLOOD

WARNINGS FOR THE USER:

- Do not look directly into the light - it may cause damage or even loss of vision.
- Install only in specialized workshops or professional services.
- Use in open space only.
- Use in accordance to the purpose.

INSTALLATION INSTRUCTIONS:

- It should be used exclusively in accordance with intended use.
- Mount exclusively in specialized workshops.
- The connection between the lamp and vehicle's installation should be isolated with heat-shrink tube or alternatively with isolating tape to avoid getting water and moisture to the copper wire of the lamp which can damage electronic components. When it comes to lamp and plug, the plug should be mounted safely.
- Do not cut off tinned ends.
- Lamps must be installed only in accordance with UNECE regulations.



www.myKAMAR.com

PHOTO AND TECHNICAL DRAWING:

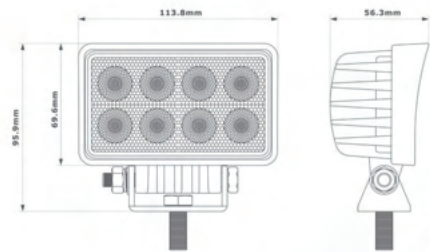

TECHNICAL SPECIFICATIONS:

MATERIAL	LED/LM QUANTITY	MOUNTING	WIRE	FUNCTION	WATT	VOLTAGE	CERTIFICATES	PACKING - BULK BOX
• Lens: PC • Housing: AL	• 8 LED • 1826 LM	• screws	• 500 mm	• work light • flood	• 21W	• 12 V/24V	• ECE R10	• cart. dim.: 130x110x65mm • weight: 565g • 20 pcs/bulk box

We reserve the right to change technical data and any errors. Photos and specifications are for reference only, and the actual product may vary slightly. Reproduction in whole or parts of the catalog without written authorization is prohibited.



**REFERENCE:
L0128**

LED WORK LAMP 13XLED OVAL FLOOD

WARNINGS FOR THE USER:

- Do not look directly into the light - it may cause damage or even loss of vision.
- Install only in specialized workshops or professional services.
- Use in open space only.
- Use in accordance to the purpose.

INSTALLATION INSTRUCTIONS:

- It should be used exclusively in accordance with intended use.
- Mount exclusively in specialized workshops.
- The connection between the lamp and vehicle's installation should be isolated with heat-shrink tube or alternatively with isolating tape to avoid getting water and moisture to the copper wire of the lamp which can damage electronic components. When it comes to lamp and plug, the plug should be mounted safely.
- Do not cut off tinned ends.
- Lamps must be installed only in accordance with UNECE regulations.



www.myKAMAR.com

PHOTO AND TECHNICAL DRAWING:

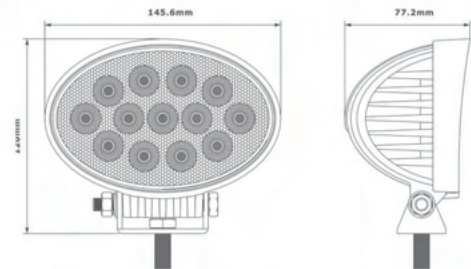

TECHNICAL SPECIFICATIONS:

MATERIAL	LED/LM QUANTITY	MOUNTING	WIRE	FUNCTION	WATT	VOLTAGE	CERTIFICATES	PACKING - BULK BOX
• Lens: PC • Housing: AL	• 13 LED • 2316 LM	• screw	• 500 mm	• work light • flood	• 31W	• 12V/24V	• ECE R10	• cart. dim.: 160x125x85mm • weight: 795g • 20 pcs/bulk box

We reserve the right to change technical data and any errors. Photos and specifications are for reference only, and the actual product may vary slightly. Reproduction in whole or parts of the catalog without written authorization is prohibited.



**REFERENCE:
L0151**

**LAMPA ROBOCZA 16X LED 48W
FLOOD**

WARNINGS FOR THE USER:

- Do not look directly into the light - it may cause damage or even loss of vision.
- Install only in specialized workshops or professional services.
- Use in open space only.
- Use in accordance to the purpose.

INSTALLATION INSTRUCTIONS:

- It should be used exclusively in accordance with intended use.
- Mount exclusively in specialized workshops.
- The connection between the lamp and vehicle's installation should be isolated with heat-shrink tube or alternatively with isolating tape to avoid getting water and moisture to the copper wire of the lamp which can damage electronic components. When it comes to lamp and plug, the plug should be mounted safely.
- Do not cut off tinned ends.
- Lamps must be installed only in accordance with UNECE regulations.



www.myKAMAR.com

PHOTO AND TECHNICAL DRAWING:

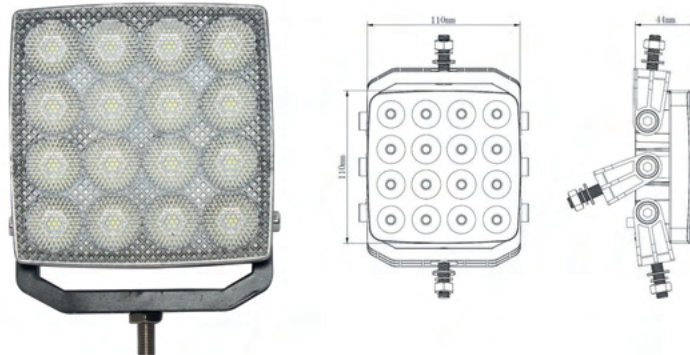

TECHNICAL SPECIFICATIONS:



MATERIAL	LED/LM QUANTITY	MOUNTING	WIRE	FUNCTION	WATT	VOLTAGE	CERTIFICATES	PACKING - BULK BOX
• Lens: PC • Housing: AL	• 16 LED • 2665 LM	• screw	• 250 mm	• work light • flood	• 48W	• 12V/24V	• ECE R10	• cart. dim.: 119x65x148mm • weight: 450g • 20 pcs/bulk box

We reserve the right to change technical data and any errors. Photos and specifications are for reference only, and the actual product may vary slightly. Reproduction in whole or parts of the catalog without written authorization is prohibited.



**REFERENCE:
L0153**

**LED WORK LAMP 12X LED ROUND
WITH SWITCH**

WARNINGS FOR THE USER:

- Do not look directly into the light - it may cause damage or even loss of vision.
- Install only in specialized workshops or professional services.
- Use in open space only.
- Use in accordance to the purpose.

INSTALLATION INSTRUCTIONS:

- It should be used exclusively in accordance with intended use.
- Mount exclusively in specialized workshops.
- The connection between the lamp and vehicle's installation should be isolated with heat-shrink tube or alternatively with isolating tape to avoid getting water and moisture to the copper wire of the lamp which can damage electronic components. When it comes to lamp and plug, the plug should be mounted safely.
- Do not cut off tinned ends.
- Lamps must be installed only in accordance with UNECE regulations.



www.myKAMAR.com

PHOTO AND TECHNICAL DRAWING:



TECHNICAL SPECIFICATIONS:



MATERIAL	LED/LM QUANTITY	MOUNTING	WIRE	FUNCTION	WATT	VOLTAGE	CERTIFICATES	PACKING - BULK BOX
• Lens: PC • Housing: AL	• 12 LED • 1311 LM	• screw	• 250 mm	• work light • flood • switch	• 12W	• 12V/24V	• ECE R10	• cart. dim.: 87x58.5x44mm • weight: 280g • 40 pcs/bulk box

We reserve the right to change technical data and any errors. Photos and specifications are for reference only, and the actual product may vary slightly. Reproduction in whole or parts of the catalog without written authorization is prohibited.



**REFERENCE:
L0154**

**LED WORK LAMP 16X LED
SQUARE WITH SWITCH**

WARNINGS FOR THE USER:

- Do not look directly into the light - it may cause damage or even loss of vision.
- Install only in specialized workshops or professional services.
- Use in open space only.
- Use in accordance to the purpose.

INSTALLATION INSTRUCTIONS:

- It should be used exclusively in accordance with intended use.
- Mount exclusively in specialized workshops.
- The connection between the lamp and vehicle's installation should be isolated with heat-shrink tube or alternatively with isolating tape to avoid getting water and moisture to the copper wire of the lamp which can damage electronic components. When it comes to lamp and plug, the plug should be mounted safely.
- Do not cut off tinned ends.
- Lamps must be installed only in accordance with UNECE regulations.



www.myKAMAR.com

PHOTO AND TECHNICAL DRAWING:



OFF/ON

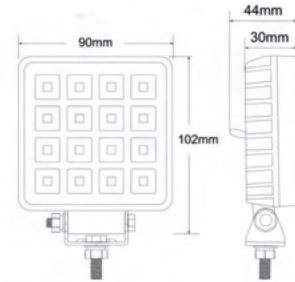

TECHNICAL SPECIFICATIONS:



MATERIAL	LED/LM QUANTITY	MOUNTING	WIRE	FUNCTION	WATT	VOLTAGE	CERTIFICATES	PACKING - BULK BOX
• Lens: PC • Housing: AL	• 16 LED • 1844 LM	• screw	• 250 mm	• work light • flood • switch	• 16W	• 12V/24V	• ECE R10	• cart. dim.: 102x55,5x109mm • weight: 350g • 40 pcs/bulk box

We reserve the right to change technical data and any errors. Photos and specifications are for reference only, and the actual product may vary slightly. Reproduction in whole or parts of the catalog without written authorization is prohibited.



**REFERENCE:
L0155**

**LED WORK LAMP 16X LED ROUND
WITH SWITCH**

WARNINGS FOR THE USER:

- Do not look directly into the light - it may cause damage or even loss of vision.
- Install only in specialized workshops or professional services.
- Use in open space only.
- Use in accordance to the purpose.

INSTALLATION INSTRUCTIONS:

- It should be used exclusively in accordance with intended use.
- Mount exclusively in specialized workshops.
- The connection between the lamp and vehicle's installation should be isolated with heat-shrink tube or alternatively with isolating tape to avoid getting water and moisture to the copper wire of the lamp which can damage electronic components. When it comes to lamp and plug, the plug should be mounted safely.
- Do not cut off tinned ends.
- Lamps must be installed only in accordance with UNECE regulations.



www.myKAMAR.com

PHOTO AND TECHNICAL DRAWING:



OFF/ON

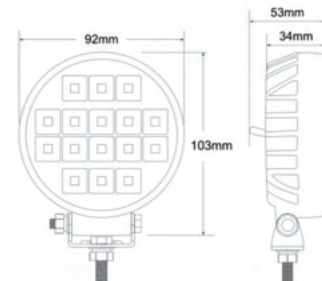

TECHNICAL SPECIFICATIONS:



MATERIAL	LED/LM QUANTITY	MOUNTING	WIRE	FUNCTION	WATT	VOLTAGE	CERTIFICATES	PACKING - BULK BOX
• Lens: PC • Housing: AL	• 16 LED • 1800 LM	• screws	• 250 mm	• work light • flood	• 24W	• 12 V/24V	• ECE R10	• cart. dim.: 102x55,5x109mm • weight: 350g • 40 pcs/bulk box

We reserve the right to change technical data and any errors. Photos and specifications are for reference only, and the actual product may vary slightly. Reproduction in whole or parts of the catalog without written authorization is prohibited.



**REFERENCE:
L0156**

**LED WORK LAMP 30X LED
SQUARE WITH SWITCH**

WARNINGS FOR THE USER:

- Do not look directly into the light - it may cause damage or even loss of vision.
- Install only in specialized workshops or professional services.
- Use in open space only.
- Use in accordance to the purpose.

INSTALLATION INSTRUCTIONS:

- It should be used exclusively in accordance with intended use.
- Mount exclusively in specialized workshops.
- The connection between the lamp and vehicle's installation should be isolated with heat-shrink tube or alternatively with isolating tape to avoid getting water and moisture to the copper wire of the lamp which can damage electronic components. When it comes to lamp and plug, the plug should be mounted safely.
- Do not cut off tinned ends.
- Lamps must be installed only in accordance with UNECE regulations.



www.myKAMAR.com

PHOTO AND TECHNICAL DRAWING:



OFF/ON

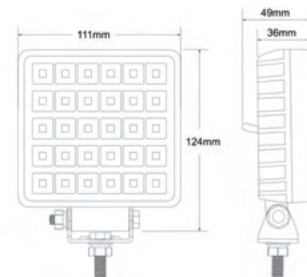

TECHNICAL SPECIFICATIONS:

MATERIAL	LED/LM QUANTITY	MOUNTING	WIRE	FUNCTION	WATT	VOLTAGE	CERTIFICATES	PACKING - BULK BOX
• Lens: PC • Housing: AL	• 30 LED • 2875 LM	• screw	• 250 mm	• work light • flood • switch	• 24W	• 12V/24V	• ECE R10	• cart. dim.: 212x66.5x148mm • weight: 610g • 20 pcs/bulk box



We reserve the right to change technical data and any errors. Photos and specifications are for reference only, and the actual product may vary slightly. Reproduction in whole or parts of the catalog without written authorization is prohibited.



**REFERENCE:
L0157**

**LED WORK LAMP 24X LED
ROUND WITH SWITCH**

WARNINGS FOR THE USER:

- Do not look directly into the light - it may cause damage or even loss of vision.
- Install only in specialized workshops or professional services.
- Use in open space only.
- Use in accordance to the purpose.

INSTALLATION INSTRUCTIONS:

- It should be used exclusively in accordance with intended use.
- Mount exclusively in specialized workshops.
- The connection between the lamp and vehicle's installation should be isolated with heat-shrink tube or alternatively with isolating tape to avoid getting water and moisture to the copper wire of the lamp which can damage electronic components. When it comes to lamp and plug, the plug should be mounted safely.
- Do not cut off tinned ends.
- Lamps must be installed only in accordance with UNECE regulations.

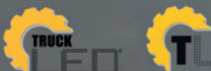

www.myKAMAR.com

PHOTO AND TECHNICAL DRAWING:



OFF/ON

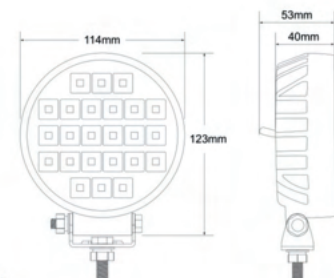

TECHNICAL SPECIFICATIONS:

MATERIAL	LED/LM QUANTITY	MOUNTING	WIRE	FUNCTION	WATT	VOLTAGE	CERTIFICATES	PACKING - BULK BOX
• Lens: PC • Housing: AL	• 24 LED • 2907 LM	• screw	• 250 mm	• work light • flood • switch	• 24W	• 12V/24V	• ECE R10	• cart. dim.: 212x66.5x148mm • weight: 610g • 20 pcs/bulk box



We reserve the right to change technical data and any errors. Photos and specifications are for reference only, and the actual product may vary slightly. Reproduction in whole or parts of the catalog without written authorization is prohibited.



**REFERENCE:
L0160**

**LED WORK LAMP 16X LED
SQUARE**

WARNINGS FOR THE USER:

- Do not look directly into the light - it may cause damage or even loss of vision.
- Install only in specialized workshops or professional services.
- Use in open space only.
- Use in accordance to the purpose.

INSTALLATION INSTRUCTIONS:

- It should be used exclusively in accordance with intended use.
- Mount exclusively in specialized workshops.
- The connection between the lamp and vehicle's installation should be isolated with heat-shrink tube or alternatively with isolating tape to avoid getting water and moisture to the copper wire of the lamp which can damage electronic components. When it comes to lamp and plug, the plug should be mounted safely.
- Do not cut off tinned ends.
- Lamps must be installed only in accordance with UNECE regulations.



www.myKAMAR.com

PHOTO AND TECHNICAL DRAWING:



TECHNICAL SPECIFICATIONS:

MATERIAL	LED/LM QUANTITY	MOUNTING	WIRE	FUNCTION	WATT	VOLTAGE	CERTIFICATES	PACKING - BULK BOX
• Lens: PC • Housing: AL	• 16 LED • 1600 LM	• screw	• 300 mm	• work light • flood	• 16W	• 12V/24V	• ECE R10	• cart. dim.: 90x55x110mm • weight: 357g • 40 pcs/bulk box

We reserve the right to change technical data and any errors. Photos and specifications are for reference only, and the actual product may vary slightly. Reproduction in whole or parts of the catalog without written authorization is prohibited.



**REFERENCE:
L0161**

**LED WORK LAMP 16X LED
SQUARE WITH SWITCH**

WARNINGS FOR THE USER:

- Do not look directly into the light - it may cause damage or even loss of vision.
- Install only in specialized workshops or professional services.
- Use in open space only.
- Use in accordance to the purpose.

INSTALLATION INSTRUCTIONS:

- It should be used exclusively in accordance with intended use.
- Mount exclusively in specialized workshops.
- The connection between the lamp and vehicle's installation should be isolated with heat-shrink tube or alternatively with isolating tape to avoid getting water and moisture to the copper wire of the lamp which can damage electronic components. When it comes to lamp and plug, the plug should be mounted safely.
- Do not cut off tinned ends.
- Lamps must be installed only in accordance with UNECE regulations.



www.myKAMAR.com

PHOTO AND TECHNICAL DRAWING:



TECHNICAL SPECIFICATIONS:

MATERIAL	LED/LM QUANTITY	MOUNTING	WIRE	FUNCTION	WATT	VOLTAGE	CERTIFICATES	PACKING - BULK BOX
• Lens: PC • Housing: AL	• 16 LED • 1600 LM	• screw	• 300 mm	• work light • flood	• 16W	• 12V/24V	• ECE R10	• cart. dim.: 90x55x110mm • weight: 365g • 40 pcs/bulk box

We reserve the right to change technical data and any errors. Photos and specifications are for reference only, and the actual product may vary slightly. Reproduction in whole or parts of the catalog without written authorization is prohibited.



REFERENCE:
L0163

LED WORK LAMP 6XLED

WARNINGS FOR THE USER:

- Do not look directly into the light - it may cause damage or even loss of vision.
- Install only in specialized workshops or professional services.
- Use in open space only.
- Use in accordance to the purpose.

INSTALLATION INSTRUCTIONS:

- It should be used exclusively in accordance with intended use.
- Mount exclusively in specialized workshops.
- The connection between the lamp and vehicle's installation should be isolated with heat-shrink tube or alternatively with isolating tape to avoid getting water and moisture to the copper wire of the lamp which can damage electronic components. When it comes to lamp and plug, the plug should be mounted safely.
- Do not cut off tinned ends.
- Lamps must be installed only in accordance with UNECE regulations.



www.myKAMAR.com

PHOTO AND TECHNICAL DRAWING:

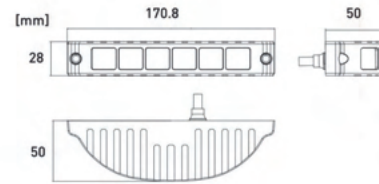

TECHNICAL SPECIFICATIONS:



MATERIAL	LED/LM QUANTITY	MOUNTING	WIRE	FUNCTION	WATT	VOLTAGE	CERTIFICATES	PACKING - BULK BOX
• Lens: PC • Housing: AL	• 6 LED • 826 LM	• screw	• 250 mm	• work light • flood	• 16W	• 12V/24V	• ECE R10	• cart. dim.: 176x35x72mm • weight: 220g • 40 pcs/bulk box

We reserve the right to change technical data and any errors. Photos and specifications are for reference only, and the actual product may vary slightly. Reproduction in whole or parts of the catalog without written authorization is prohibited.



REFERENCE:
L0164

LED WORK LAMP 8XLED

WARNINGS FOR THE USER:

- Do not look directly into the light - it may cause damage or even loss of vision.
- Install only in specialized workshops or professional services.
- Use in open space only.
- Use in accordance to the purpose.

INSTALLATION INSTRUCTIONS:

- It should be used exclusively in accordance with intended use.
- Mount exclusively in specialized workshops.
- The connection between the lamp and vehicle's installation should be isolated with heat-shrink tube or alternatively with isolating tape to avoid getting water and moisture to the copper wire of the lamp which can damage electronic components. When it comes to lamp and plug, the plug should be mounted safely.
- Do not cut off tinned ends.
- Lamps must be installed only in accordance with UNECE regulations.

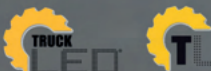

www.myKAMAR.com

PHOTO AND TECHNICAL DRAWING:

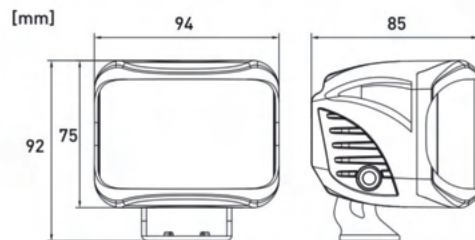

TECHNICAL SPECIFICATIONS:



MATERIAL	LED/LM QUANTITY	MOUNTING	WIRE	FUNCTION	WATT	VOLTAGE	CERTIFICATES	PACKING - BULK BOX
• Lens: PC • Housing: AL	• 8 LED • 1608 LM	• screw	• 250 mm	• work light • flood	• 27W	• 12V/24V	• ECE R10	• cart. dim.: 185x130x100mm • weight: 650g • 20 pcs/bulk box

We reserve the right to change technical data and any errors. Photos and specifications are for reference only, and the actual product may vary slightly. Reproduction in whole or parts of the catalog without written authorization is prohibited.



**REFERENCE:
L0165**

LED WORK LAMP 42XLED

WARNINGS FOR THE USER:

- Do not look directly into the light - it may cause damage or even loss of vision.
- Install only in specialized workshops or professional services.
- Use in open space only.
- Use in accordance to the purpose.

INSTALLATION INSTRUCTIONS:

- It should be used exclusively in accordance with intended use.
- Mount exclusively in specialized workshops.
- The connection between the lamp and vehicle's installation should be isolated with heat-shrink tube or alternatively with isolating tape to avoid getting water and moisture to the copper wire of the lamp which can damage electronic components. When it comes to lamp and plug, the plug should be mounted safely.
- Do not cut off tinned ends.
- Lamps must be installed only in accordance with UNECE regulations.



www.myKAMAR.com

PHOTO AND TECHNICAL DRAWING:

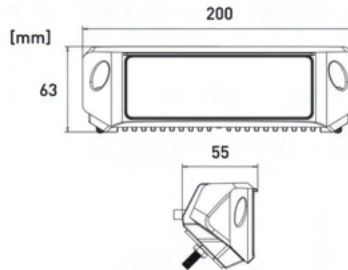

TECHNICAL SPECIFICATIONS:

MATERIAL	LED/LM QUANTITY	MOUNTING	WIRE	FUNCTION	WATT	VOLTAGE	CERTIFICATES	PACKING - BULK BOX
• Lens: PC • Housing: AL	• 42 LED • 2800 LM	• screw	• 250 mm	• work light • flood	• 46W	• 12V/24V	• ECE R10	• cart. dim.: 208x72x70mm • weight: 500g • 20 pcs/bulk box

We reserve the right to change technical data and any errors. Photos and specifications are for reference only, and the actual product may vary slightly. Reproduction in whole or parts of the catalog without written authorization is prohibited.



**REFERENCE:
L0166**

WORK LAMP 16XLED

WARNINGS FOR THE USER:

- Do not look directly into the light - it may cause damage or even loss of vision.
- Install only in specialized workshops or professional services.
- Use in open space only.
- Use in accordance to the purpose.

INSTALLATION INSTRUCTIONS:

- It should be used exclusively in accordance with intended use.
- Mount exclusively in specialized workshops.
- The connection between the lamp and vehicle's installation should be isolated with heat-shrink tube or alternatively with isolating tape to avoid getting water and moisture to the copper wire of the lamp which can damage electronic components. When it comes to lamp and plug, the plug should be mounted safely.
- Do not cut off tinned ends.
- Lamps must be installed only in accordance with UNECE regulations.



www.myKAMAR.com

PHOTO AND TECHNICAL DRAWING:

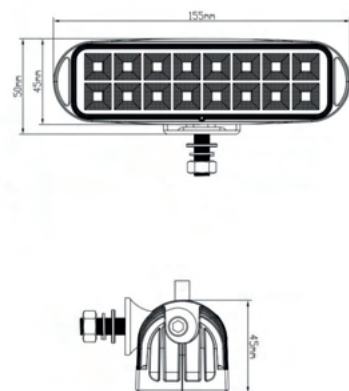

TECHNICAL SPECIFICATIONS:

MATERIAL	LED/LM QUANTITY	MOUNTING	WIRE	FUNCTION	WATT	VOLTAGE	CERTIFICATES	PACKING - BULK BOX
• Lens: PC • Housing: AL	• 16 LED • 1732 LM	• screw	• 250 mm	• work light • flood	• 24W	• 12V/24V	• ECE R10	• cart. dim.: 190x60x56mm • weight: 300g • 40 pcs/bulk box

We reserve the right to change technical data and any errors. Photos and specifications are for reference only, and the actual product may vary slightly. Reproduction in whole or parts of the catalog without written authorization is prohibited.



**REFERENCE:
L0167**

WORK LAMP 10XLED

WARNINGS FOR THE USER:

- Do not look directly into the light - it may cause damage or even loss of vision.
- Install only in specialized workshops or professional services.
- Use in open space only.
- Use in accordance to the purpose.

INSTALLATION INSTRUCTIONS:

- It should be used exclusively in accordance with intended use.
- Mount exclusively in specialized workshops.
- The connection between the lamp and vehicle's installation should be isolated with heat-shrink tube or alternatively with isolating tape to avoid getting water and moisture to the copper wire of the lamp which can damage electronic components. When it comes to lamp and plug, the plug should be mounted safely.
- Do not cut off tinned ends.
- Lamps must be installed only in accordance with UNECE regulations.



www.myKAMAR.com

PHOTO AND TECHNICAL DRAWING:

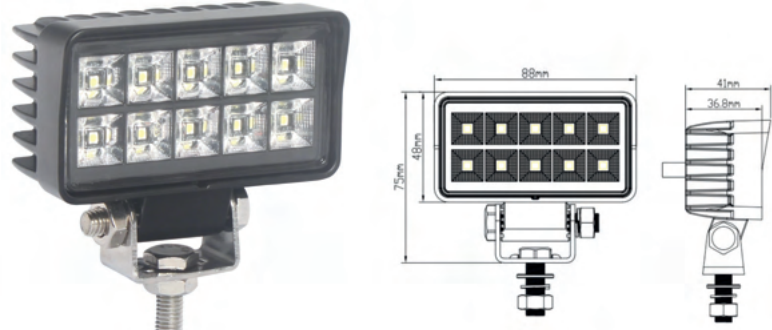

TECHNICAL SPECIFICATIONS:



MATERIAL	LED/LM QUANTITY	MOUNTING	WIRE	FUNCTION	WATT	VOLTAGE	CERTIFICATES	PACKING - BULK BOX
• Lens: PC • Housing: AL	• 10 LED • 1600 LM	• screw	• 250mm	• work light • flood	• 15W	• 12/24V	• ECE R10	• cart. dim.: 95x56x98mm • weight: 280g • 40 pcs/bulk box

We reserve the right to change technical data and any errors. Photos and specifications are for reference only, and the actual product may vary slightly. Reproduction in whole or parts of the catalog without written authorization is prohibited.



**REFERENCE:
L0168**

WORK LAMP 13XLED

WARNINGS FOR THE USER:

- Do not look directly into the light - it may cause damage or even loss of vision.
- Install only in specialized workshops or professional services.
- Use in open space only.
- Use in accordance to the purpose.

INSTALLATION INSTRUCTIONS:

- It should be used exclusively in accordance with intended use.
- Mount exclusively in specialized workshops.
- The connection between the lamp and vehicle's installation should be isolated with heat-shrink tube or alternatively with isolating tape to avoid getting water and moisture to the copper wire of the lamp which can damage electronic components. When it comes to lamp and plug, the plug should be mounted safely.
- Do not cut off tinned ends.
- Lamps must be installed only in accordance with UNECE regulations.



www.myKAMAR.com

PHOTO AND TECHNICAL DRAWING:

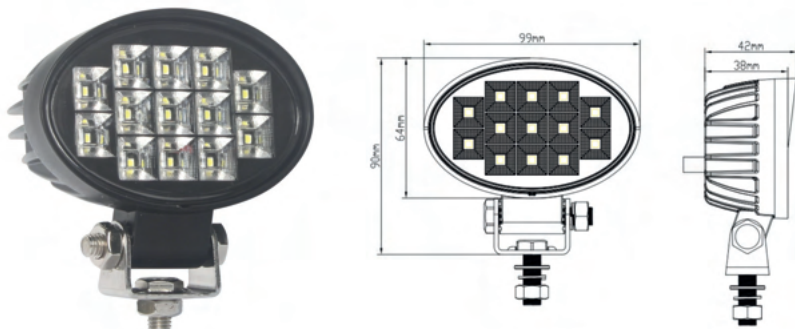

TECHNICAL SPECIFICATIONS:



MATERIAL	LED/LM QUANTITY	MOUNTING	WIRE	FUNCTION	WATT	VOLTAGE	CERTIFICATES	PACKING - BULK BOX
• Lens: PC • Housing: AL	• 13 LED • 1200 LM	• screw	• 250mm	• work light • flood	• 19W	• 12/24V	• ECE R10	• cart. dim.: 100x56x115mm • weight: 290g • 40 pcs/bulk box

We reserve the right to change technical data and any errors. Photos and specifications are for reference only, and the actual product may vary slightly. Reproduction in whole or parts of the catalog without written authorization is prohibited.



**REFERENCE:
L0169**

WORK LAMP 18XLED WITH SWITCH

WARNINGS FOR THE USER:

- Do not look directly into the light - it may cause damage or even loss of vision.
- Install only in specialized workshops or professional services.
- Use in open space only.
- Use in accordance to the purpose.

INSTALLATION INSTRUCTIONS:

- It should be used exclusively in accordance with intended use.
- Mount exclusively in specialized workshops.
- The connection between the lamp and vehicle's installation should be isolated with heat-shrink tube or alternatively with isolating tape to avoid getting water and moisture to the copper wire of the lamp which can damage electronic components. When it comes to lamp and plug, the plug should be mounted safely.
- Do not cut off tinned ends.
- Lamps must be installed only in accordance with UNECE regulations.



www.myKAMAR.com

PHOTO AND TECHNICAL DRAWING:

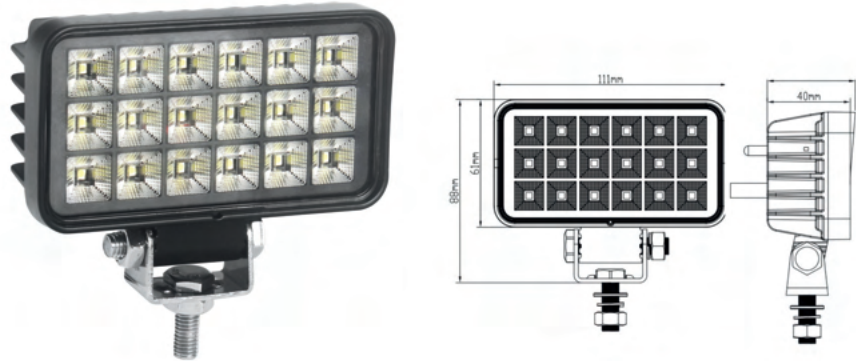

TECHNICAL SPECIFICATIONS:

MATERIAL	LED/LM QUANTITY	MOUNTING	WIRE	FUNCTION	WATT	VOLTAGE	CERTIFICATES	PACKING - BULK BOX
• Lens: PC • Housing: AL	• 18 LED • 2008 LM	• screw	• 250mm	• work light • flood • switch on housing	• 27W	• 12/24V	• ECE R10	• cart. dim.: 118x60x115mm • weight: 300g • 20 pcs/bulk box

We reserve the right to change technical data and any errors. Photos and specifications are for reference only, and the actual product may vary slightly. Reproduction in whole or parts of the catalog without written authorization is prohibited.



**REFERENCE:
L0170**

WORK LAMP 27XLED WITH SWITCH

WARNINGS FOR THE USER:

- Do not look directly into the light - it may cause damage or even loss of vision.
- Install only in specialized workshops or professional services.
- Use in open space only.
- Use in accordance to the purpose.

INSTALLATION INSTRUCTIONS:

- It should be used exclusively in accordance with intended use.
- Mount exclusively in specialized workshops.
- The connection between the lamp and vehicle's installation should be isolated with heat-shrink tube or alternatively with isolating tape to avoid getting water and moisture to the copper wire of the lamp which can damage electronic components. When it comes to lamp and plug, the plug should be mounted safely.
- Do not cut off tinned ends.
- Lamps must be installed only in accordance with UNECE regulations.



www.myKAMAR.com

PHOTO AND TECHNICAL DRAWING:

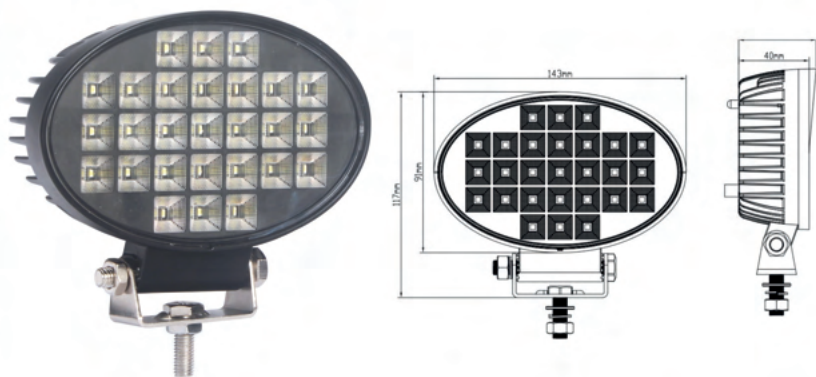

TECHNICAL SPECIFICATIONS:

MATERIAL	LED/LM QUANTITY	MOUNTING	WIRE	FUNCTION	WATT	VOLTAGE	CERTIFICATES	PACKING - BULK BOX
• Lens: PC • Housing: AL	• 27 LED • 2500 LM	• screw	• 250mm	• work light • flood • switch on housing	• 40W	• 12/24V	• ECE R10	• cart. dim.: 150x90x148mm • weight: 300g • 20 pcs/bulk box

We reserve the right to change technical data and any errors. Photos and specifications are for reference only, and the actual product may vary slightly. Reproduction in whole or parts of the catalog without written authorization is prohibited.



REFERENCE:
L0171

WORK LAMP 12XLED

WARNINGS FOR THE USER:

- Do not look directly into the light - it may cause damage or even loss of vision.
- Install only in specialized workshops or professional services.
- Use in open space only.
- Use in accordance to the purpose.

INSTALLATION INSTRUCTIONS:

- It should be used exclusively in accordance with intended use.
- Mount exclusively in specialized workshops.
- The connection between the lamp and vehicle's installation should be isolated with heat-shrink tube or alternatively with isolating tape to avoid getting water and moisture to the copper wire of the lamp which can damage electronic components. When it comes to lamp and plug, the plug should be mounted safely.
- Do not cut off tinned ends.
- Lamps must be installed only in accordance with UNECE regulations.



www.myKAMAR.com

PHOTO AND TECHNICAL DRAWING:

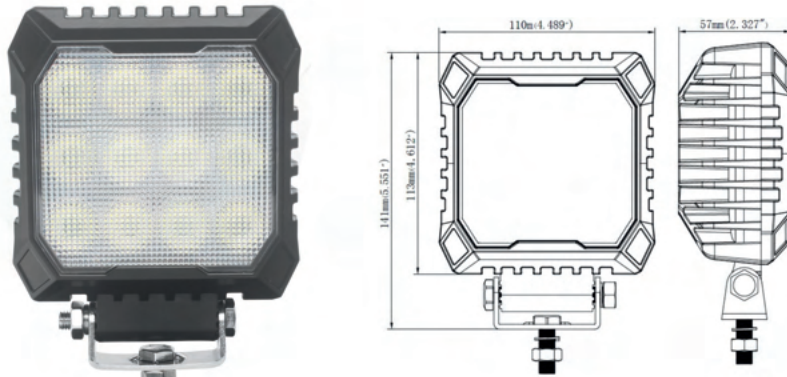

TECHNICAL SPECIFICATIONS:



MATERIAL	LED/LM QUANTITY	MOUNTING	WIRE	FUNCTION	WATT	VOLTAGE	CERTIFICATES	PACKING - BULK BOX
• Lens: PC • Housing: AL	• 12 LED • 4400 LM	• screw	• 250mm	• work light • flood	• 40W	• 12/24V	• ECE R10	• cart. dim.: 139x193x80mm • weight: 700g • 20 pcs/bulk box

We reserve the right to change technical data and any errors. Photos and specifications are for reference only, and the actual product may vary slightly. Reproduction in whole or parts of the catalog without written authorization is prohibited.



REFERENCE:
L0172

WORK LAMP 18XLED

WARNINGS FOR THE USER:

- Do not look directly into the light - it may cause damage or even loss of vision.
- Install only in specialized workshops or professional services.
- Use in open space only.
- Use in accordance to the purpose.

INSTALLATION INSTRUCTIONS:

- It should be used exclusively in accordance with intended use.
- Mount exclusively in specialized workshops.
- The connection between the lamp and vehicle's installation should be isolated with heat-shrink tube or alternatively with isolating tape to avoid getting water and moisture to the copper wire of the lamp which can damage electronic components. When it comes to lamp and plug, the plug should be mounted safely.
- Do not cut off tinned ends.
- Lamps must be installed only in accordance with UNECE regulations.



www.myKAMAR.com

PHOTO AND TECHNICAL DRAWING:

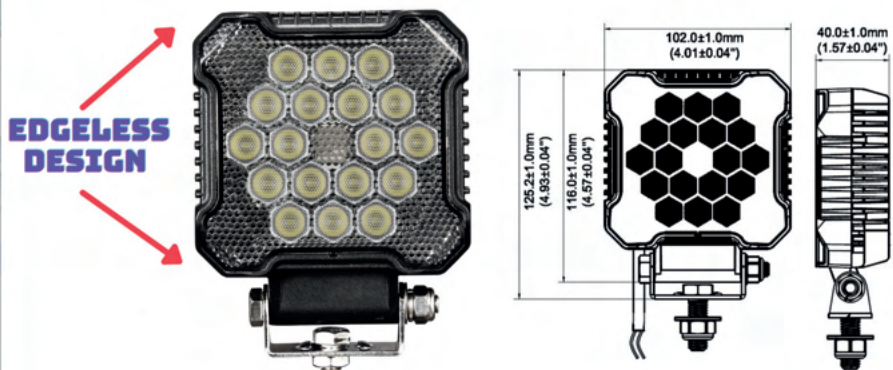

TECHNICAL SPECIFICATIONS:



MATERIAL	LED/LM QUANTITY	MOUNTING	WIRE	FUNCTION	WATT	VOLTAGE	CERTIFICATES	PACKING - BULK BOX
• Lens: PC • Housing: AL	• 18 LED • 2800 LM	• screw	• 350mm	• work light • flood • vibration protect 15G RMS 24-2000HZ	• 20W	• 12/24V	• ECE R10	• cart. dim.: 157x107x60mm • weight: 610g • 20 pcs/bulk box

We reserve the right to change technical data and any errors. Photos and specifications are for reference only, and the actual product may vary slightly. Reproduction in whole or parts of the catalog without written authorization is prohibited.



**REFERENCE:
L0173**

WORK LAMP 18XLED WITH DT CONNECTOR

WARNINGS FOR THE USER:

- Do not look directly into the light - it may cause damage or even loss of vision.
- Install only in specialized workshops or professional services.
- Use in open space only.
- Use in accordance to the purpose.

INSTALLATION INSTRUCTIONS:

- It should be used exclusively in accordance with intended use.
- Mount exclusively in specialized workshops.
- The connection between the lamp and vehicle's installation should be isolated with heat-shrink tube or alternatively with isolating tape to avoid getting water and moisture to the copper wire of the lamp which can damage electronic components. When it comes to lamp and plug, the plug should be mounted safely.
- Do not cut off tinned ends.
- Lamps must be installed only in accordance with UNECE regulations.



www.myKAMAR.com

PHOTO AND TECHNICAL DRAWING:

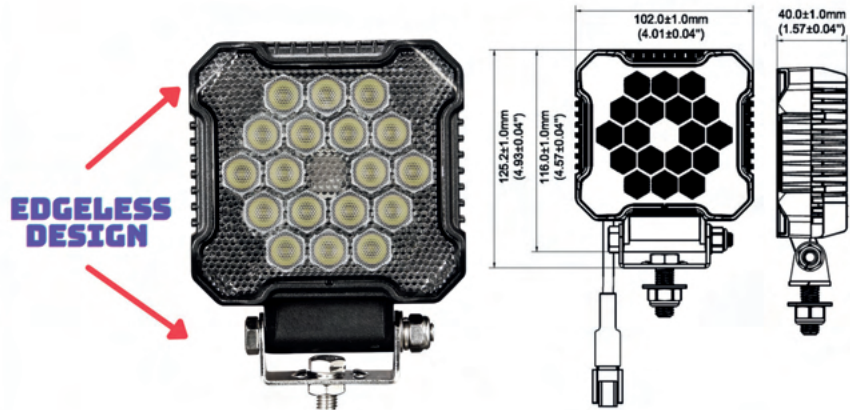

TECHNICAL SPECIFICATIONS:



MATERIAL	LED/LM QUANTITY	MOUNTING	WIRE	FUNCTION	WATT	VOLTAGE	CERTIFICATES	PACKING - BULK BOX
• Lens: PC • Housing: AL	• 18 LED • 2800 LM	• screw	• 380mm with DT connector	• work light • flood • vibration protect 15G RMS 24-2000HZ	• 26W	• 12/24V	• ECE R10	• cart. dim: 157x107x60mm • weight: 620g • 20 pcs/bulk box

We reserve the right to change technical data and any errors. Photos and specifications are for reference only, and the actual product may vary slightly. Reproduction in whole or parts of the catalog without written authorization is prohibited.



**REFERENCE:
L0174**

WORK LAMP 4XLED FLOOD

WARNINGS FOR THE USER:

- Do not look directly into the light - it may cause damage or even loss of vision.
- Install only in specialized workshops or professional services.
- Use in open space only.
- Use in accordance to the purpose.

INSTALLATION INSTRUCTIONS:

- It should be used exclusively in accordance with intended use.
- Mount exclusively in specialized workshops.
- The connection between the lamp and vehicle's installation should be isolated with heat-shrink tube or alternatively with isolating tape to avoid getting water and moisture to the copper wire of the lamp which can damage electronic components. When it comes to lamp and plug, the plug should be mounted safely.
- Do not cut off tinned ends.
- Lamps must be installed only in accordance with UNECE regulations.



www.myKAMAR.com

PHOTO AND TECHNICAL DRAWING:



TECHNICAL SPECIFICATIONS:



MATERIAL	LED/LM QUANTITY	MOUNTING	WIRE	FUNCTION	WATT	VOLTAGE	CERTIFICATES	PACKING/WEIGHT
• Lens: PC • Housing: AL	• 4 LED • 1800 LM	• screw	• 250 mm	• work light • flood	• 18W	• 12 V24V	• ECE R10	• cart. dim: 85x70x70mm • weight: 220g • 60 pcs/bulk box

We reserve the right to change technical data and any errors. Photos and specifications are for reference only, and the actual product may vary slightly. Reproduction in whole or parts of the catalog without written authorization is prohibited.



**REFERENCE:
L0175**

WORK LAMP 4XLED SPOT

WARNINGS FOR THE USER:

- Do not look directly into the light - it may cause damage or even loss of vision.
- Install only in specialized workshops or professional services.
- Use in open space only.
- Use in accordance to the purpose.

INSTALLATION INSTRUCTIONS:

- It should be used exclusively in accordance with intended use.
- Mount exclusively in specialized workshops.
- The connection between the lamp and vehicle's installation should be isolated with heat-shrink tube or alternatively with isolating tape to avoid getting water and moisture to the copper wire of the lamp which can damage electronic components. When it comes to lamp and plug, the plug should be mounted safely.
- Do not cut off tinned ends.
- Lamps must be installed only in accordance with UNECE regulations.



www.myKAMAR.com

PHOTO AND TECHNICAL DRAWING:

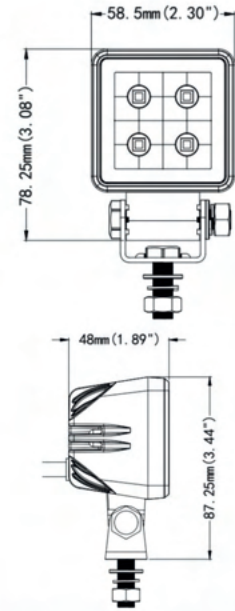

TECHNICAL SPECIFICATIONS:

MATERIAL	LED/LM QUANTITY	MOUNTING	WIRE	FUNCTION	WATT	VOLTAGE	CERTIFICATES	PACKING/WEIGHT
• Lens: PC • Housing: AL	• 4 LED • 1800 LM	• screw	• 250 mm	• work light • flood	• 18 W	• 12 V/24V	• ECE R10 • ECE R148 • ECE R149	• cart dim: 85x70x70mm • weight: 220g • 60 pcs/bulk box

We reserve the right to change technical data and any errors. Photos and specifications are for reference only, and the actual product may vary slightly. Reproduction in whole or parts of the catalog without written authorization is prohibited.



**REFERENCE:
L0176**

WORK LAMP 9XLED ROUND PLUS

WARNINGS FOR THE USER:

- Do not look directly into the light - it may cause damage or even loss of vision.
- Install only in specialized workshops or professional services.
- Use in open space only.
- Use in accordance to the purpose.

INSTALLATION INSTRUCTIONS:

- It should be used exclusively in accordance with intended use.
- Mount exclusively in specialized workshops.
- The connection between the lamp and vehicle's installation should be isolated with heat-shrink tube or alternatively with isolating tape to avoid getting water and moisture to the copper wire of the lamp which can damage electronic components. When it comes to lamp and plug, the plug should be mounted safely.
- Do not cut off tinned ends.
- Lamps must be installed only in accordance with UNECE regulations.



www.myKAMAR.com

PHOTO AND TECHNICAL DRAWING:

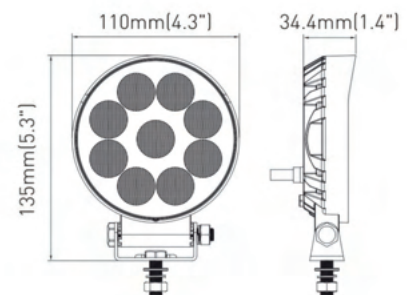

TECHNICAL SPECIFICATIONS:

MATERIAL	LED/LM QUANTITY	MOUNTING	WIRE	FUNCTION	WATT	VOLTAGE	CERTIFICATES	PACKING/WEIGHT
• Lens: PC • Housing: AL	• 9 • 1133 LM	• screw	• 250 mm	• work light • flood	• 20 W	• 12 V/24V	• ECER10	• cart dim: 110x65x148mm • weight: 290g • 20 pcs/bulk box

We reserve the right to change technical data and any errors. Photos and specifications are for reference only, and the actual product may vary slightly. Reproduction in whole or parts of the catalog without written authorization is prohibited.



**REFERENCE:
L0177**

WORK LAMP 9XLED SQUARE PLUS

WARNINGS FOR THE USER:

- Do not look directly into the light - it may cause damage or even loss of vision.
- Install only in specialized workshops or professional services.
- Use in open space only.
- Use in accordance to the purpose.

INSTALLATION INSTRUCTIONS:

- It should be used exclusively in accordance with intended use.
- Mount exclusively in specialized workshops.
- The connection between the lamp and vehicle's installation should be isolated with heat-shrink tube or alternatively with isolating tape to avoid getting water and moisture to the copper wire of the lamp which can damage electronic components. When it comes to lamp and plug, the plug should be mounted safely.
- Do not cut off tinned ends.
- Lamps must be installed only in accordance with UNECE regulations.



www.myKAMAR.com

PHOTO AND TECHNICAL DRAWING:

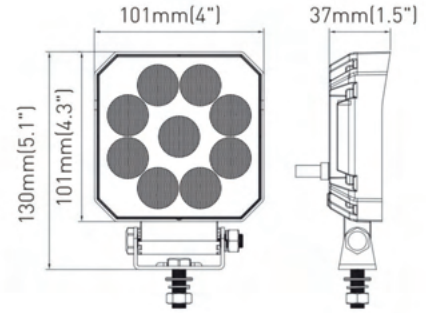

TECHNICAL SPECIFICATIONS:



MATERIAL	LED/LM QUANTITY	MOUNTING	WIRE	FUNCTION	WATT	VOLTAGE	CERTIFICATES	PACKING/WEIGHT
• Lens: PC • Housing: AL	• 9 LED • 1133 LM	• screw	• 250 mm	• work light • flood	• 20W	• 12 V/24V	• ECE R10	• cart. dim.: 119x65x148mm • weight: 290g • 20 pcs/bulk box

We reserve the right to change technical data and any errors. Photos and specifications are for reference only, and the actual product may vary slightly. Reproduction in whole or parts of the catalog without written authorization is prohibited.



**REFERENCE:
L0178**

WORK LAMP X16 LED SQUARE PLUS

WARNINGS FOR THE USER:

- Do not look directly into the light - it may cause damage or even loss of vision.
- Install only in specialized workshops or professional services.
- Use in open space only.
- Use in accordance to the purpose.

INSTALLATION INSTRUCTIONS:

- It should be used exclusively in accordance with intended use.
- Mount exclusively in specialized workshops.
- The connection between the lamp and vehicle's installation should be isolated with heat-shrink tube or alternatively with isolating tape to avoid getting water and moisture to the copper wire of the lamp which can damage electronic components. When it comes to lamp and plug, the plug should be mounted safely.
- Do not cut off tinned ends.
- Lamps must be installed only in accordance with UNECE regulations.



www.myKAMAR.com

PHOTO AND TECHNICAL DRAWING:

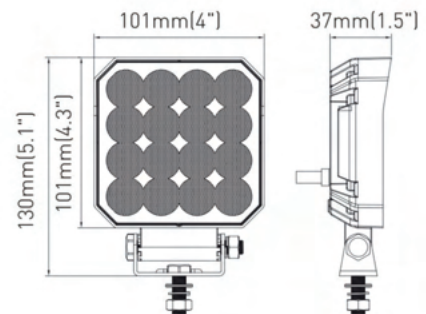

TECHNICAL SPECIFICATIONS:



MATERIAL	LED/LM QUANTITY	MOUNTING	WIRE	FUNCTION	WATT	VOLTAGE	CERTIFICATES	PACKING - BULK BOX
• Lens: PC • Housing: AL	• 16 LED • 1600 LM	• screws	• 250 mm	• work light • flood	• 20W	• 12 V/24V	• ECE R10	• cart. dim.: 119x65x148mm • weight: 450g • 20 pcs/bulk box

We reserve the right to change technical data and any errors. Photos and specifications are for reference only, and the actual product may vary slightly. Reproduction in whole or parts of the catalog without written authorization is prohibited.



REFERENCE:
L0179

WORK LAMP 3XLED TRIANGLE

WARNINGS FOR THE USER:

- Do not look directly into the light - it may cause damage or even loss of vision.
- Install only in specialized workshops or professional services.
- Use in open space only.
- Use in accordance to the purpose.

INSTALLATION INSTRUCTIONS:

- It should be used exclusively in accordance with intended use.
- Mount exclusively in specialized workshops.
- The connection between the lamp and vehicle's installation should be isolated with heat-shrink tube or alternatively with isolating tape to avoid getting water and moisture to the copper wire of the lamp which can damage electronic components. When it comes to lamp and plug, the plug should be mounted safely.
- Do not cut off tinned ends.
- Lamps must be installed only in accordance with UNECE regulations.



www.myKAMAR.com

PHOTO AND TECHNICAL DRAWING:

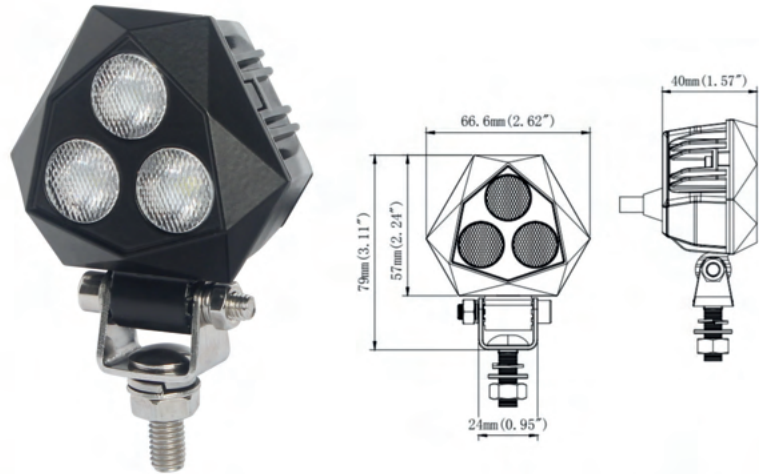

TECHNICAL SPECIFICATIONS:



MATERIAL	LED/LM QUANTITY	MOUNTING	WIRE	FUNCTION	WATT	VOLTAGE	CERTIFICATES	PACKING/WEIGHT
• Lens: PC • Housing: AL	• 3 LED • 911 LM	• screw	• 250 mm	• work light • flood	• 9W	• 12 V/24V	• ECE R10	• cart. dim.: 85x70x70mm • weight: 220g • 60 pcs/bulk box

We reserve the right to change technical data and any errors. Photos and specifications are for reference only, and the actual product may vary slightly. Reproduction in whole or parts of the catalog without written authorization is prohibited.



REFERENCE:
L0180

WORK LAMP 6XLED 12/24V

WARNINGS FOR THE USER:

- Do not look directly into the light - it may cause damage or even loss of vision.
- Install only in specialized workshops or professional services.
- Use in open space only.
- Use in accordance to the purpose.

INSTALLATION INSTRUCTIONS:

- It should be used exclusively in accordance with intended use.
- Mount exclusively in specialized workshops.
- The connection between the lamp and vehicle's installation should be isolated with heat-shrink tube or alternatively with isolating tape to avoid getting water and moisture to the copper wire of the lamp which can damage electronic components. When it comes to lamp and plug, the plug should be mounted safely.
- Do not cut off tinned ends.
- Lamps must be installed only in accordance with UNECE regulations.



www.myKAMAR.com

PHOTO AND TECHNICAL DRAWING:

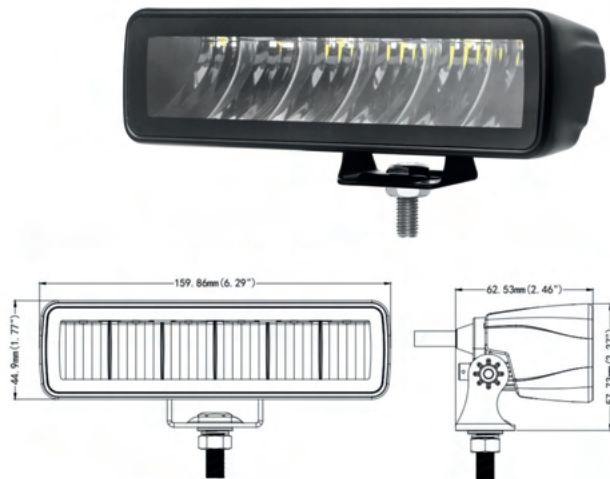

TECHNICAL SPECIFICATIONS:



MATERIAL	LED/LM QUANTITY	MOUNTING	WIRE	FUNCTION	WATT	VOLTAGE	CERTIFICATES	PACKING/WEIGHT
• Lens: PC • Housing: AL	• 6 LED • 1200 LM	• screw	• 250 mm	• work light • spot	• 18W	• 12 V/24V	• ECE R10	• cart. dim.: 196x78x52mm • weight: 1050g • 20 pcs/bulk box

We reserve the right to change technical data and any errors. Photos and specifications are for reference only, and the actual product may vary slightly. Reproduction in whole or parts of the catalog without written authorization is prohibited.



**REFERENCE:
L0181**

**WORK LAMP SQUARE 16XLED +
STRIPE LED**

WARNINGS FOR THE USER:

- Do not look directly into the light - it may cause damage or even loss of vision.
- Install only in specialized workshops or professional services.
- Use in open space only.
- Use in accordance to the purpose.

INSTALLATION INSTRUCTIONS:

- It should be used exclusively in accordance with intended use.
- Mount exclusively in specialized workshops.
- The connection between the lamp and vehicle's installation should be isolated with heat-shrink tube or alternatively with isolating tape to avoid getting water and moisture to the copper wire of the lamp which can damage electronic components. When it comes to lamp and plug, the plug should be mounted safely.
- Do not cut off tinned ends.
- Lamps must be installed only in accordance with UNECE regulations.



www.myKAMAR.com

PHOTO AND TECHNICAL DRAWING:

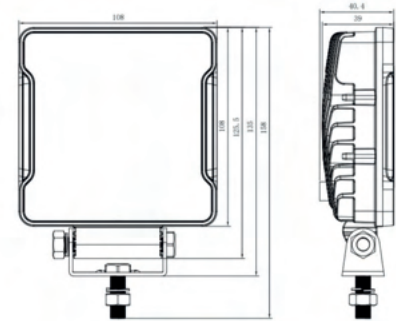
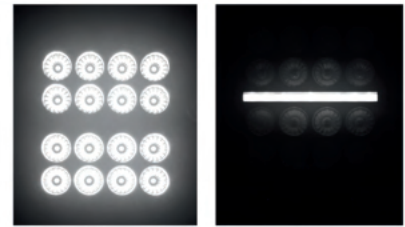

TECHNICAL SPECIFICATIONS:

MATERIAL	LED/LM QUANTITY	MOUNTING	WIRE	FUNCTION	WATT	VOLTAGE	CERTIFICATES	PACKING/WEIGHT
• Lens: PC • Housing: AL	• 16•9 • LM 1717	• screw	• 250 mm	• work light • flood	• 20W • 1.5W	• 12 V/24V	• ECE R10	• cart. dim.: 119x65x148mm • weight: 500g • 20 pcs/bulk box

We reserve the right to change technical data and any errors. Photos and specifications are for reference only, and the actual product may vary slightly. Reproduction in whole or parts of the catalog without written authorization is prohibited.



**REFERENCE:
L0182**

**WORK LAMP ROUND 14XLED +
STRIPE LED**

WARNINGS FOR THE USER:

- Do not look directly into the light - it may cause damage or even loss of vision.
- Install only in specialized workshops or professional services.
- Use in open space only.
- Use in accordance to the purpose.

INSTALLATION INSTRUCTIONS:

- It should be used exclusively in accordance with intended use.
- Mount exclusively in specialized workshops.
- The connection between the lamp and vehicle's installation should be isolated with heat-shrink tube or alternatively with isolating tape to avoid getting water and moisture to the copper wire of the lamp which can damage electronic components. When it comes to lamp and plug, the plug should be mounted safely.
- Do not cut off tinned ends.
- Lamps must be installed only in accordance with UNECE regulations.



www.myKAMAR.com

PHOTO AND TECHNICAL DRAWING:

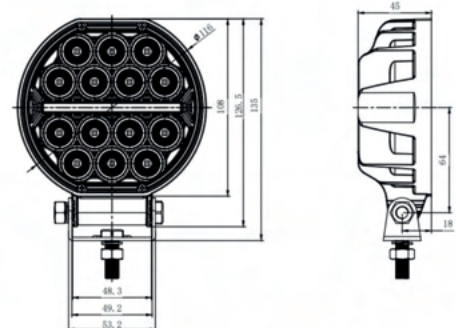
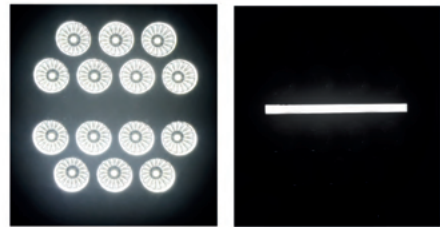

TECHNICAL SPECIFICATIONS:

MATERIAL	LED/LM QUANTITY	MOUNTING	WIRE	FUNCTION	WATT	VOLTAGE	CERTIFICATES	PACKING/WEIGHT
• Lens: PC • Housing: AL	• 14•9 LED • 1300 LM	• screw	• 250mm	• work light • flood	• 18W • 1.6W	• 12 V/24V	• ECE R10	• cart. dim.: 119x65x148mm • weight: 500g • 20 pcs/bulk box

We reserve the right to change technical data and any errors. Photos and specifications are for reference only, and the actual product may vary slightly. Reproduction in whole or parts of the catalog without written authorization is prohibited.



**REFERENCE:
L0183**

**WORK LAMP 4XLED + 1XLED
CONVEX LENS**

WARNINGS FOR THE USER:

- Do not look directly into the light - it may cause damage or even loss of vision.
- Install only in specialized workshops or professional services.
- Use in open space only.
- Use in accordance to the purpose.

INSTALLATION INSTRUCTIONS:

- It should be used exclusively in accordance with intended use.
- Mount exclusively in specialized workshops.
- The connection between the lamp and vehicle's installation should be isolated with heat-shrink tube or alternatively with isolating tape to avoid getting water and moisture to the copper wire of the lamp which can damage electronic components. When it comes to lamp and plug, the plug should be mounted safely.
- Do not cut off tinned ends.
- Lamps must be installed only in accordance with UNECE regulations.



www.myKAMAR.com

PHOTO AND TECHNICAL DRAWING:

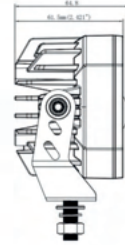
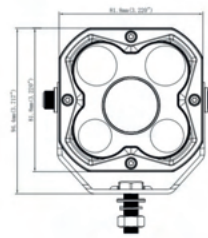
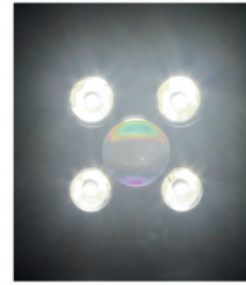

TECHNICAL SPECIFICATIONS:

MATERIAL	LED/LM QUANTITY	MOUNTING	WIRE	FUNCTION	WATT	VOLTAGE	CERTIFICATES	PACKING/WEIGHT
• Lens: PC • Housing: AL	• 4+1 • LM 2700	• screw	• 250mm	• work light • flood	• 29W	• 12 V/24V	• ECE R10	• cart. dim.: 157x134x87mm • weight: 500g • 20 pcs/bulk box

We reserve the right to change technical data and any errors. Photos and specifications are for reference only, and the actual product may vary slightly. Reproduction in whole or parts of the catalog without written authorization is prohibited.



**REFERENCE:
L0184**

**WORK LAMP 10XLED + 2X
STRAP LED WHITE**

WARNINGS FOR THE USER:

- Do not look directly into the light - it may cause damage or even loss of vision.
- Install only in specialized workshops or professional services.
- Use in open space only.
- Use in accordance to the purpose.

INSTALLATION INSTRUCTIONS:

- It should be used exclusively in accordance with intended use.
- Mount exclusively in specialized workshops.
- The connection between the lamp and vehicle's installation should be isolated with heat-shrink tube or alternatively with isolating tape to avoid getting water and moisture to the copper wire of the lamp which can damage electronic components. When it comes to lamp and plug, the plug should be mounted safely.
- Do not cut off tinned ends.
- Lamps must be installed only in accordance with UNECE regulations.



www.myKAMAR.com

PHOTO AND TECHNICAL DRAWING:

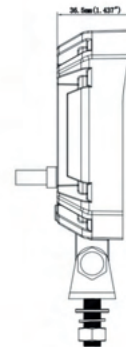
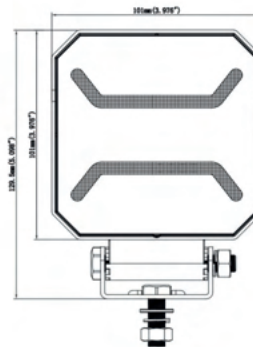
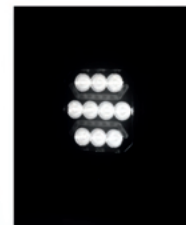

TECHNICAL SPECIFICATIONS:

MATERIAL	LED/LM QUANTITY	MOUNTING	WIRE	FUNCTION	WATT	VOLTAGE	CERTIFICATES	PACKING/WEIGHT
• Lens: PC • Housing: AL	• 10 LED • 1500 LM	• screw	• 250 mm	• working lamp	• 15W	• 12 V/24V	• ECE R10	• cart. dim.: 345x315x260mm • weight: 500g • 20 pcs/bulk box

We reserve the right to change technical data and any errors. Photos and specifications are for reference only, and the actual product may vary slightly. Reproduction in whole or parts of the catalog without written authorization is prohibited.



**REFERENCE:
L0185**

**WORK LAMP 10XLED + 2X
STRAP LED AMBER**

WARNINGS FOR THE USER:

- Do not look directly into the light - it may cause damage or even loss of vision.
- Install only in specialized workshops or professional services.
- Use in open space only.
- Use in accordance to the purpose.

INSTALLATION INSTRUCTIONS:

- It should be used exclusively in accordance with intended use.
- Mount exclusively in specialized workshops.
- The connection between the lamp and vehicle's installation should be isolated with heat-shrink tube or alternatively with isolating tape to avoid getting water and moisture to the copper wire of the lamp which can damage electronic components. When it comes to lamp and plug, the plug should be mounted safely.
- Do not cut off tinned ends.
- Lamps must be installed only in accordance with UNECE regulations.



www.myKAMAR.com

PHOTO AND TECHNICAL DRAWING:

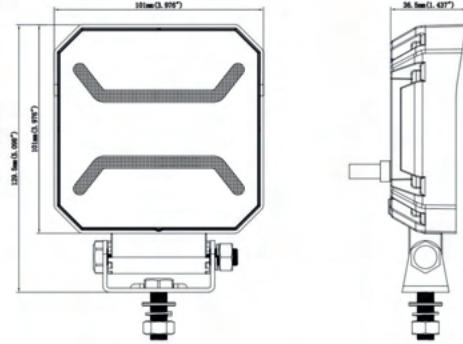
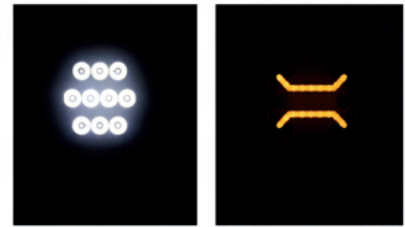

TECHNICAL SPECIFICATIONS:

MATERIAL	LED/LM QUANTITY	MOUNTING	WIRE	FUNCTION	WATT	VOLTAGE	CERTIFICATES	PACKING/WEIGHT
• Lens: PC • Housing: AL	• 10 LED • 1500 LM	• screw	• 250 mm	• working lamp	• 15W	• 12V/24V	• ECE R10	• cart. dim.: 345x315x260mm • weight: 500g • 20 pcs/bulk box

We reserve the right to change technical data and any errors. Photos and specifications are for reference only, and the actual product may vary slightly. Reproduction in whole or parts of the catalog without written authorization is prohibited.



**REFERENCE:
L0186**

WORK LAMP 4XLED + BLUE

WARNINGS FOR THE USER:

- Do not look directly into the light - it may cause damage or even loss of vision.
- Install only in specialized workshops or professional services.
- Use in open space only.
- Use in accordance to the purpose.

INSTALLATION INSTRUCTIONS:

- It should be used exclusively in accordance with intended use.
- Mount exclusively in specialized workshops.
- The connection between the lamp and vehicle's installation should be isolated with heat-shrink tube or alternatively with isolating tape to avoid getting water and moisture to the copper wire of the lamp which can damage electronic components. When it comes to lamp and plug, the plug should be mounted safely.
- Do not cut off tinned ends.
- Lamps must be installed only in accordance with UNECE regulations.

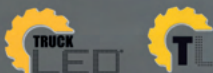

www.myKAMAR.com

PHOTO AND TECHNICAL DRAWING:

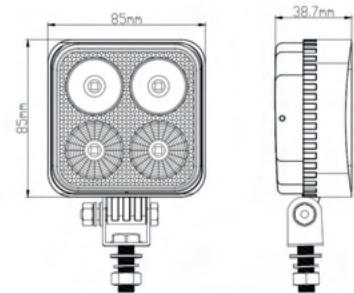

TECHNICAL SPECIFICATIONS:

MATERIAL	LED/LM QUANTITY	MOUNTING	WIRE	FUNCTION	WATT	VOLTAGE	CERTIFICATES	PACKING/WEIGHT
• Lens: PC • Housing: AL	• 4 LED	• screws	• 300mm	• work lamp • flood	• 12W	• 9-32V	• ECE R10	• cart. dim.: 100x50x110mm • weight: 350g • 40 pcs/bulk box

We reserve the right to change technical data and any errors. Photos and specifications are for reference only, and the actual product may vary slightly. Reproduction in whole or parts of the catalog without written authorization is prohibited.



**REFERENCE:
L2204**

LED WORK LAMP 5 LED, 10-30V

WARNINGS FOR THE USER:

- Do not look directly into the light - it may cause damage or even loss of vision.
- Install only in specialized workshops or professional services.
- Use in open space only.
- Use in accordance to the purpose.

INSTALLATION INSTRUCTIONS:

- It should be used exclusively in accordance with intended use.
- Mount exclusively in specialized workshops.
- The connection between the lamp and vehicle's installation should be isolated with heat-shrink tube or alternatively with isolating tape to avoid getting water and moisture to the copper wire of the lamp which can damage electronic components. When it comes to lamp and plug, the plug should be mounted safely.
- Do not cut off tinned ends.
- Lamps must be installed only in accordance with UNECE regulations.



www.myKAMAR.com

PHOTO AND TECHNICAL DRAWING:

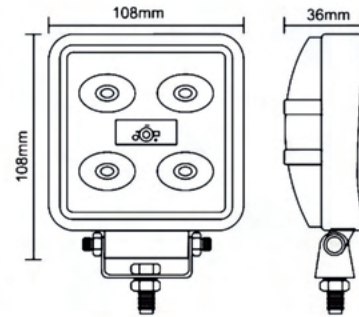

TECHNICAL SPECIFICATIONS:

MATERIAL	LED/LM QUANTITY	MOUNTING	WIRE	FUNCTION	WATT	VOLTAGE	CERTIFICATES	PACKING - BULK BOX
• Lens: PC • Housing: AL	• 5 LED • 600 LM	• screw	• 400mm	• work light • flood	• 14W	• 12V/24V	• ECE R10	• cart. dim: 150x130x50mm • lamp weight: 480g • 40 pcs/bulk box



We reserve the right to change technical data and any errors. Photos and specifications are for reference only, and the actual product may vary slightly. Reproduction in whole or parts of the catalog without written authorization is prohibited.



**REFERENCE:
L2205**

LED WORK LAMP ROUND 6 LED

WARNINGS FOR THE USER:

- Do not look directly into the light - it may cause damage or even loss of vision.
- Install only in specialized workshops or professional services.
- Use in open space only.
- Use in accordance to the purpose.

INSTALLATION INSTRUCTIONS:

- It should be used exclusively in accordance with intended use.
- Mount exclusively in specialized workshops.
- The connection between the lamp and vehicle's installation should be isolated with heat-shrink tube or alternatively with isolating tape to avoid getting water and moisture to the copper wire of the lamp which can damage electronic components. When it comes to lamp and plug, the plug should be mounted safely.
- Do not cut off tinned ends.
- Lamps must be installed only in accordance with UNECE regulations.



www.myKAMAR.com

PHOTO AND TECHNICAL DRAWING:

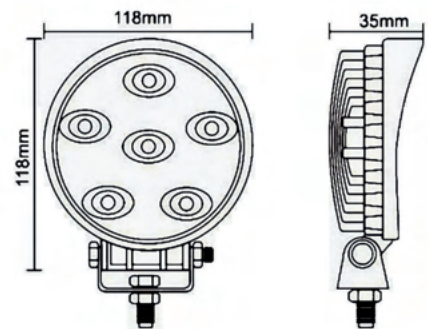

TECHNICAL SPECIFICATIONS:

MATERIAL	LED/LM QUANTITY	MOUNTING	WIRE	FUNCTION	WATT	VOLTAGE	CERTIFICATES	PACKING - BULK BOX
• Lens: PC • Housing: AL	• 6 LED • 670 LM	• screw	• 400mm	• work light • flood	• 15W	• 12V/24V	• ECE R10	• cart. dim: 150x130x50mm • lamp weight: 480g • 40 pcs/bulk box



We reserve the right to change technical data and any errors. Photos and specifications are for reference only, and the actual product may vary slightly. Reproduction in whole or parts of the catalog without written authorization is prohibited.

LED PANELS





REFERENCE:
LB0003

LED PANEL LED 12X

WARNINGS FOR THE USER:

- Do not look directly into the light - it may cause damage or even loss of vision.
- Install only in specialized workshops or professional services.
- Use in open space only.
- Use in accordance to the purpose.

INSTALLATION INSTRUCTIONS:

- It should be used exclusively in accordance with intended use.
- Mount exclusively in specialized workshops.
- The connection between the lamp and vehicle's installation should be isolated with heat shrink tube, or, alternatively, with isolating tape, to avoid getting water and moisture to the copper wire of the lamp, which can damage electronic components. When it comes to lamp and plug, the plug should be mounted safely.
- Do not cut off tinned ends.
- Lamps must be installed only in accordance with UNECE regulations
- Only mount the lamp to a flat, metal, dry, cleaned and degreased roof surface. The maximum speed of movement of the vehicle with a warning lamp attached with a magnet to the roof surface is 50km/h. Take special care in windy conditions. Do not unscrew the lamp, it will lose its water resistance.



www.myKAMAR.com

PHOTO AND TECHNICAL DRAWING:

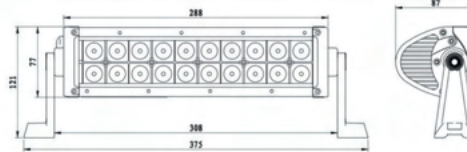

TECHNICAL SPECIFICATIONS:

MATERIAL	LED/LM QUANTITY	MOUNTING	WIRE	FUNCTION	WATT	VOLTAGE	CERTIFICATES	PACKING - BULK BOX
• Housing: AL • Lens: PC	• 20 LED • 1533 LM	• screw	• 300 mm	• work light • combo	• 36W	• 12/24V	• ECE R10	• cart. dim.: 330x110x130mm • weight: 1350g • 8 pcs/bulk box

We reserve the right to change technical data and any errors. Photos and specifications are for reference only, and the actual product may vary slightly. Reproduction in whole or parts of the catalog without written authorization is prohibited.



REFERENCE:
LB0004

PANEL 40 X LED

WARNINGS FOR THE USER:

- Do not look directly into the light - it may cause damage or even loss of vision.
- Install only in specialized workshops or professional services.
- Use in open space only.
- Use in accordance to the purpose.

INSTALLATION INSTRUCTIONS:

- It should be used exclusively in accordance with intended use.
- Mount exclusively in specialized workshops.
- The connection between the lamp and vehicle's installation should be isolated with heat shrink tube, or, alternatively, with isolating tape, to avoid getting water and moisture to the copper wire of the lamp, which can damage electronic components. When it comes to lamp and plug, the plug should be mounted safely.
- Do not cut off tinned ends.
- Lamps must be installed only in accordance with UNECE regulations
- Only mount the lamp to a flat, metal, dry, cleaned and degreased roof surface. The maximum speed of movement of the vehicle with a warning lamp attached with a magnet to the roof surface is 50km/h. Take special care in windy conditions. Do not unscrew the lamp, it will lose its water resistance.

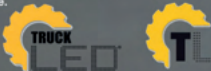

www.myKAMAR.com

PHOTO AND TECHNICAL DRAWING:

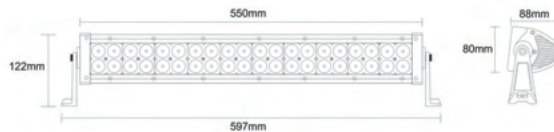

TECHNICAL SPECIFICATIONS:

MATERIAL	LED/LM QUANTITY	MOUNTING	WIRE	FUNCTION	WATT	VOLTAGE	CERTIFICATES	PACKING - BULK BOX
• Housing: AL • Lens: PC	• 40 LED • 4463 LM	• screws	• 250 mm	• work light • combo	• 120W	• 12/24V	• ECE R10	• cart. dim.: 680x120x120mm • weight: 2850g • 4 pcs/bulk box

We reserve the right to change technical data and any errors. Photos and specifications are for reference only, and the actual product may vary slightly. Reproduction in whole or parts of the catalog without written authorization is prohibited.



REFERENCE:
LB0004V

PANEL LED 40X LED CURVED

WARNINGS FOR THE USER:

- Do not look directly into the light - it may cause damage or even loss of vision.
- Install only in specialized workshops or professional services.
- Use in open space only.
- Use in accordance to the purpose.

INSTALLATION INSTRUCTIONS:

- It should be used exclusively in accordance with intended use.
- Mount exclusively in specialized workshops.
- The connection between the lamp and vehicle's installation should be isolated with heat shrink tube, or, alternatively, with isolating tape, to avoid getting water and moisture to the copper wire of the lamp, which can damage electronic components. When it comes to lamp and plug, the plug should be mounted safely.
- Do not cut off tinned ends.
- Lamps must be installed only in accordance with UNECE regulations
- Only mount the lamp to a flat, metal, dry, cleaned and degreased roof surface. The maximum speed of movement of the vehicle with a warning lamp attached with a magnet to the roof surface is 50km/h. Take special care in windy conditions. Do not unscrew the lamp, it will lose its water resistance.



www.myKAMAR.com

PHOTO AND TECHNICAL DRAWING:

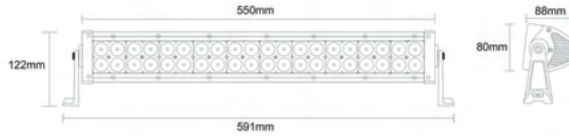

TECHNICAL SPECIFICATIONS:

MATERIAL	LED/LM QUANTITY	MOUNTING	WIRE	FUNCTION	WATT	VOLTAGE	CERTIFICATES	PACKING - BULK BOX
• Housing: AL • Lens: PC	• 40 LED • 4964 LM	• screws	• 250 mm	• work light • combo	• 120W	• 12/24V	• ECE R10	• cart. dim.: 680x120x120mm • weight: 2500g • 4 pcs/bulk box

We reserve the right to change technical data and any errors. Photos and specifications are for reference only, and the actual product may vary slightly. Reproduction in whole or parts of the catalog without written authorization is prohibited.



REFERENCE:
LB0005

LED PANEL LED 60X

WARNINGS FOR THE USER:

- Do not look directly into the light - it may cause damage or even loss of vision.
- Install only in specialized workshops or professional services.
- Use in open space only.
- Use in accordance to the purpose.

INSTALLATION INSTRUCTIONS:

- It should be used exclusively in accordance with intended use.
- Mount exclusively in specialized workshops.
- The connection between the lamp and vehicle's installation should be isolated with heat shrink tube, or, alternatively, with isolating tape, to avoid getting water and moisture to the copper wire of the lamp, which can damage electronic components. When it comes to lamp and plug, the plug should be mounted safely.
- Do not cut off tinned ends.
- Lamps must be installed only in accordance with UNECE regulations
- Only mount the lamp to a flat, metal, dry, cleaned and degreased roof surface. The maximum speed of movement of the vehicle with a warning lamp attached with a magnet to the roof surface is 50km/h. Take special care in windy conditions. Do not unscrew the lamp, it will lose its water resistance.



www.myKAMAR.com

PHOTO AND TECHNICAL DRAWING:

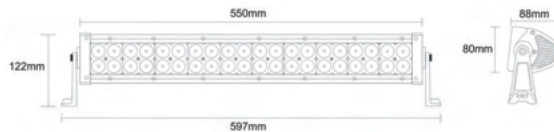

TECHNICAL SPECIFICATIONS:

MATERIAL	LED/LM QUANTITY	MOUNTING	WIRE	FUNCTION	WATT	VOLTAGE	CERTIFICATES	PACKING - BULK BOX
• Housing: AL • Lens: PC	• 60 LED • 6527 LM	• screws	• 250 mm	• work light • combo	• 180W	• 12/24V	• ECE R10	• cart. dim.: 930x120x120mm • weight: 3450g • 4 pcs/bulk box

We reserve the right to change technical data and any errors. Photos and specifications are for reference only, and the actual product may vary slightly. Reproduction in whole or parts of the catalog without written authorization is prohibited.



REFERENCE:
LB0005V

PANEL LED 60X LED CURVE

WARNINGS FOR THE USER:

- Do not look directly into the light - it may cause damage or even loss of vision.
- Install only in specialized workshops or professional services.
- Use in open space only.
- Use in accordance to the purpose.

INSTALLATION INSTRUCTIONS:

- It should be used exclusively in accordance with intended use.
- Mount exclusively in specialized workshops.
- The connection between the lamp and vehicle's installation should be isolated with heat shrink tube, or, alternatively, with isolating tape, to avoid getting water and moisture to the copper wire of the lamp, which can damage electronic components. When it comes to lamp and plug, the plug should be mounted safely.
- Do not cut off tinned ends.
- Lamps must be installed only in accordance with UNECE regulations
- Only mount the lamp to a flat, metal, dry, cleaned and degreased roof surface. The maximum speed of movement of the vehicle with a warning lamp attached with a magnet to the roof surface is 50km/h. Take special care in windy conditions. Do not unscrew the lamp, it will lose its water resistance.



www.myKAMAR.com

PHOTO AND TECHNICAL DRAWING:



TECHNICAL SPECIFICATIONS:

MATERIAL	LED/LM QUANTITY	MOUNTING	WIRE	FUNCTION	WATT	VOLTAGE	CERTIFICATES	PACKING - BULK BOX
• Housing: AL • Lens: PC	• 60 LED • 6700 LM	• screws	• 250 mm	• work light • combo	• 180W	• 12/24V	• ECE R10	• cart. dim.: 930x120x120mm • weight: 3360g • 4 pcs/bulk box

We reserve the right to change technical data and any errors. Photos and specifications are for reference only, and the actual product may vary slightly. Reproduction in whole or parts of the catalog without written authorization is prohibited.



REFERENCE:
LB0006

PANEL LED 80X LED

WARNINGS FOR THE USER:

- Do not look directly into the light - it may cause damage or even loss of vision.
- Install only in specialized workshops or professional services.
- Use in open space only.
- Use in accordance to the purpose.

INSTALLATION INSTRUCTIONS:

- It should be used exclusively in accordance with intended use.
- Mount exclusively in specialized workshops.
- The connection between the lamp and vehicle's installation should be isolated with heat shrink tube, or, alternatively, with isolating tape, to avoid getting water and moisture to the copper wire of the lamp, which can damage electronic components. When it comes to lamp and plug, the plug should be mounted safely.
- Do not cut off tinned ends.
- Lamps must be installed only in accordance with UNECE regulations
- Only mount the lamp to a flat, metal, dry, cleaned and degreased roof surface. The maximum speed of movement of the vehicle with a warning lamp attached with a magnet to the roof surface is 50km/h. Take special care in windy conditions. Do not unscrew the lamp, it will lose its water resistance.



www.myKAMAR.com

PHOTO AND TECHNICAL DRAWING:



TECHNICAL SPECIFICATIONS:

MATERIAL	LED/LM QUANTITY	MOUNTING	WIRE	FUNCTION	WATT	VOLTAGE	CERTIFICATES	PACKING - BULK BOX
• Housing: AL • Lens: PC	• 80 LED • 7723 LM	• screws	• 250 mm	• work light • combo	• 240W	• 12/24V	• ECE R10	• cart. dim.: 1210x120x120mm • weight: 4680g • 4 pcs/bulk box

We reserve the right to change technical data and any errors. Photos and specifications are for reference only, and the actual product may vary slightly. Reproduction in whole or parts of the catalog without written authorization is prohibited.



REFERENCE:
LB0006V

PANEL LED 80X LED CURVE

WARNINGS FOR THE USER:

- Do not look directly into the light - it may cause damage or even loss of vision.
- Install only in specialized workshops or professional services.
- Use in open space only.
- Use in accordance to the purpose.

INSTALLATION INSTRUCTIONS:

- It should be used exclusively in accordance with intended use.
- Mount exclusively in specialized workshops.
- The connection between the lamp and vehicle's installation should be isolated with heat shrink tube, or, alternatively, with isolating tape, to avoid getting water and moisture to the copper wire of the lamp, which can damage electronic components. When it comes to lamp and plug, the plug should be mounted safely.
- Do not cut off tinned ends.
- Lamps must be installed only in accordance with UNECE regulations
- Only mount the lamp to a flat, metal, dry, cleaned and degreased roof surface. The maximum speed of movement of the vehicle with a warning lamp attached with a magnet to the roof surface is 50km/h. Take special care in windy conditions. Do not unscrew the lamp, it will lose its water resistance.

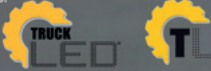

www.myKAMAR.com

PHOTO AND TECHNICAL DRAWING:



TECHNICAL SPECIFICATIONS:

MATERIAL	LED/LM QUANTITY	MOUNTING	WIRE	FUNCTION	WATT	VOLTAGE	CERTIFICATES	PACKING - BULK BOX
• Housing: AL • Lens: PC	• 80 LED • 8000 LM	• screws	• 250 mm	• work light • combo	• 240W	• 12/24V	• ECE R10	• cart. dim.: 1125x130x195mm • weight: 4250g • 4 pcs/bulk box

We reserve the right to change technical data and any errors. Photos and specifications are for reference only, and the actual product may vary slightly. Reproduction in whole or parts of the catalog without written authorization is prohibited.



REFERENCE:
LB0007

PANEL LED 96X LED

WARNINGS FOR THE USER:

- Do not look directly into the light - it may cause damage or even loss of vision.
- Install only in specialized workshops or professional services.
- Use in open space only.
- Use in accordance to the purpose.

INSTALLATION INSTRUCTIONS:

- It should be used exclusively in accordance with intended use.
- Mount exclusively in specialized workshops.
- The connection between the lamp and vehicle's installation should be isolated with heat shrink tube, or, alternatively, with isolating tape, to avoid getting water and moisture to the copper wire of the lamp, which can damage electronic components. When it comes to lamp and plug, the plug should be mounted safely.
- Do not cut off tinned ends.
- Lamps must be installed only in accordance with UNECE regulations
- Only mount the lamp to a flat, metal, dry, cleaned and degreased roof surface. The maximum speed of movement of the vehicle with a warning lamp attached with a magnet to the roof surface is 50km/h. Take special care in windy conditions. Do not unscrew the lamp, it will lose its water resistance.



www.myKAMAR.com

PHOTO AND TECHNICAL DRAWING:



TECHNICAL SPECIFICATIONS:

MATERIAL	LED/LM QUANTITY	MOUNTING	WIRE	FUNCTION	WATT	VOLTAGE	CERTIFICATES	PACKING - BULK BOX
• Housing: AL • Lens: PC	• 96 LED • 8300 LM	• screws	• 250 mm	• work light • combo	• 288W	• 12/24V	• ECE R10	• cart. dim.: 1360x120x120mm • weight: 5240g • 4 pcs/bulk box

We reserve the right to change technical data and any errors. Photos and specifications are for reference only, and the actual product may vary slightly. Reproduction in whole or parts of the catalog without written authorization is prohibited.



REFERENCE:
LB0007V

PANEL LED 96X LED CURVE

WARNINGS FOR THE USER:

- Do not look directly into the light - it may cause damage or even loss of vision.
- Install only in specialized workshops or professional services.
- Use in open space only.
- Use in accordance to the purpose.

INSTALLATION INSTRUCTIONS:

- It should be used exclusively in accordance with intended use.
- Mount exclusively in specialized workshops.
- The connection between the lamp and vehicle's installation should be isolated with heat shrink tube, or, alternatively, with isolating tape, to avoid getting water and moisture to the copper wire of the lamp, which can damage electronic components. When it comes to lamp and plug, the plug should be mounted safely.
- Do not cut off tinned ends.
- Lamps must be installed only in accordance with UNECE regulations
- Only mount the lamp to a flat, metal, dry, cleaned and degreased roof surface. The maximum speed of movement of the vehicle with a warning lamp attached with a magnet to the roof surface is 50km/h. Take special care in windy conditions. Do not unscrew the lamp, it will lose its water resistance.



www.myKAMAR.com

PHOTO AND TECHNICAL DRAWING:



TECHNICAL SPECIFICATIONS:

MATERIAL	LED/LM QUANTITY	MOUNTING	WIRE	FUNCTION	WATT	VOLTAGE	CERTIFICATES	PACKING - BULK BOX
• Housing: AL • Lens: PC	• 96 LED • 8584 LM	• screws	• 250 mm	• work light • combo	• 288W	• 12/24V	• ECE R10	• cart. dim.: 1320x130x215mm • weight: 5140g • 4 pcs/bulk box

We reserve the right to change technical data and any errors. Photos and specifications are for reference only, and the actual product may vary slightly. Reproduction in whole or parts of the catalog without written authorization is prohibited.



REFERENCE:
LB0025

PANEL LED 36W 12 LED

WARNINGS FOR THE USER:

- Do not look directly into the light - it may cause damage or even loss of vision.
- Install only in specialized workshops or professional services.
- Use in open space only.
- Use in accordance to the purpose.

INSTALLATION INSTRUCTIONS:

- It should be used exclusively in accordance with intended use.
- Mount exclusively in specialized workshops.
- The connection between the lamp and vehicle's installation should be isolated with heat shrink tube, or, alternatively, with isolating tape, to avoid getting water and moisture to the copper wire of the lamp, which can damage electronic components. When it comes to lamp and plug, the plug should be mounted safely.
- Do not cut off tinned ends.
- Lamps must be installed only in accordance with UNECE regulations
- Only mount the lamp to a flat, metal, dry, cleaned and degreased roof surface. The maximum speed of movement of the vehicle with a warning lamp attached with a magnet to the roof surface is 50km/h. Take special care in windy conditions. Do not unscrew the lamp, it will lose its water resistance.



www.myKAMAR.com

PHOTO AND TECHNICAL DRAWING:

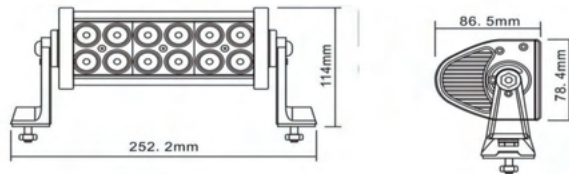

TECHNICAL SPECIFICATIONS:

MATERIAL	LED/LM QUANTITY	MOUNTING	WIRE	FUNCTION	WATT	VOLTAGE	CERTIFICATES	PACKING - BULK BOX
• Housing: AL • Lens: PC	• 12 LED • 1333 LM	• screws	• 300 mm	• work light • combo	• 22W	• 12/24V	• ECE R10	• cart. dim.: 230x110x130mm • weight: 1016,5g • 10pcs/bulk box

We reserve the right to change technical data and any errors. Photos and specifications are for reference only, and the actual product may vary slightly. Reproduction in whole or parts of the catalog without written authorization is prohibited.



REFERENCE:
LB0026

PANEL LED 72W 24 LED

WARNINGS FOR THE USER:

- Do not look directly into the light - it may cause damage or even loss of vision.
- Install only in specialized workshops or professional services.
- Use in open space only.
- Use in accordance to the purpose.

INSTALLATION INSTRUCTIONS:

- It should be used exclusively in accordance with intended use.
- Mount exclusively in specialized workshops.
- The connection between the lamp and vehicle's installation should be isolated with heat shrink tube, or, alternatively, with isolating tape, to avoid getting water and moisture to the copper wire of the lamp, which can damage electronic components. When it comes to lamp and plug, the plug should be mounted safely.
- Do not cut off tinned ends.
- Lamps must be installed only in accordance with UNECE regulations
- Only mount the lamp to a flat, metal, dry, cleaned and degreased roof surface. The maximum speed of movement of the vehicle with a warning lamp attached with a magnet to the roof surface is 50km/h. Take special care in windy conditions. Do not unscrew the lamp, it will lose its water resistance.

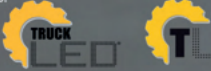

www.myKAMAR.com

PHOTO AND TECHNICAL DRAWING:

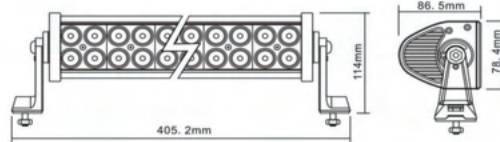

TECHNICAL SPECIFICATIONS:

MATERIAL	LED/LM QUANTITY	MOUNTING	WIRE	FUNCTION	WATT	VOLTAGE	CERTIFICATES	PACKING - BULK BOX
• Housing: AL • Lens: PC	• 24 LED • 1368 LM	• screws	• 300 mm	• work light • combo	• 41W	• 12/24V	• ECE R10	• cart. dim.: 380x110x130mm • weight: 1495,6g • 8 pcs/bulk box

We reserve the right to change technical data and any errors. Photos and specifications are for reference only, and the actual product may vary slightly. Reproduction in whole or parts of the catalog without written authorization is prohibited.



REFERENCE:
LB0027

PANEL LED 120W 40 LED

WARNINGS FOR THE USER:

- Do not look directly into the light - it may cause damage or even loss of vision.
- Install only in specialized workshops or professional services.
- Use in open space only.
- Use in accordance to the purpose.

INSTALLATION INSTRUCTIONS:

- It should be used exclusively in accordance with intended use.
- Mount exclusively in specialized workshops.
- The connection between the lamp and vehicle's installation should be isolated with heat shrink tube, or, alternatively, with isolating tape, to avoid getting water and moisture to the copper wire of the lamp, which can damage electronic components. When it comes to lamp and plug, the plug should be mounted safely.
- Do not cut off tinned ends.
- Lamps must be installed only in accordance with UNECE regulations
- Only mount the lamp to a flat, metal, dry, cleaned and degreased roof surface. The maximum speed of movement of the vehicle with a warning lamp attached with a magnet to the roof surface is 50km/h. Take special care in windy conditions. Do not unscrew the lamp, it will lose its water resistance.

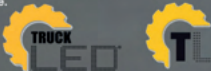

www.myKAMAR.com

PHOTO AND TECHNICAL DRAWING:

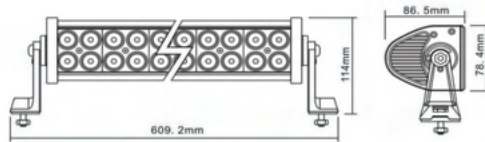

TECHNICAL SPECIFICATIONS:

MATERIAL	LED/LM QUANTITY	MOUNTING	WIRE	FUNCTION	WATT	VOLTAGE	CERTIFICATES	PACKING - BULK BOX
• Housing: AL • Lens: PC	• 40 LED • 2434 LM	• screws	• 250 mm	• work light • combo	• 120W	• 12/24V	• ECE R10	• cart. dim.: 610x110x100mm • weight: 1900g • 4 pcs/bulk box

We reserve the right to change technical data and any errors. Photos and specifications are for reference only, and the actual product may vary slightly. Reproduction in whole or parts of the catalog without written authorization is prohibited.



REFERENCE:
LB0028

PANEL LED 180W 60 LED

WARNINGS FOR THE USER:

- Do not look directly into the light - it may cause damage or even loss of vision.
- Install only in specialized workshops or professional services.
- Use in open space only.
- Use in accordance to the purpose.

INSTALLATION INSTRUCTIONS:

- It should be used exclusively in accordance with intended use.
- Mount exclusively in specialized workshops.
- The connection between the lamp and vehicle's installation should be isolated with heat shrink tube, or, alternatively, with isolating tape, to avoid getting water and moisture to the copper wire of the lamp, which can damage electronic components. When it comes to lamp and plug, the plug should be mounted safely.
- Do not cut off tinned ends.
- Lamps must be installed only in accordance with UNECE regulations
- Only mount the lamp to a flat, metal, dry, cleaned and degreased roof surface. The maximum speed of movement of the vehicle with a warning lamp attached with a magnet to the roof surface is 50km/h. Take special care in windy conditions. Do not unscrew the lamp, it will lose its water resistance.



www.myKAMAR.com

PHOTO AND TECHNICAL DRAWING:

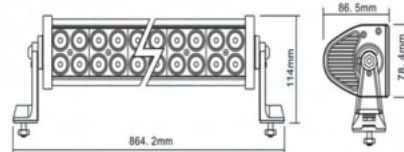

TECHNICAL SPECIFICATIONS:

MATERIAL	LED/LM QUANTITY	MOUNTING	WIRE	FUNCTION	WATT	VOLTAGE	CERTIFICATES	PACKING - BULK BOX
• Housing: AL • Lens: PC	• 60 LED • 3472 LM	• screws	• 250 mm	• work light • combo	• 180W	• 12/24V	• ECE R10	• cart. dim.: 863x110x100mm • weight: 2560g • 4 pcs/bulk box

We reserve the right to change technical data and any errors. Photos and specifications are for reference only, and the actual product may vary slightly. Reproduction in whole or parts of the catalog without written authorization is prohibited.



REFERENCE:
LB0029

PANEL LED 240W 80 LED

WARNINGS FOR THE USER:

- Do not look directly into the light - it may cause damage or even loss of vision.
- Install only in specialized workshops or professional services.
- Use in open space only.
- Use in accordance to the purpose.

INSTALLATION INSTRUCTIONS:

- It should be used exclusively in accordance with intended use.
- Mount exclusively in specialized workshops.
- The connection between the lamp and vehicle's installation should be isolated with heat shrink tube, or, alternatively, with isolating tape, to avoid getting water and moisture to the copper wire of the lamp, which can damage electronic components. When it comes to lamp and plug, the plug should be mounted safely.
- Do not cut off tinned ends.
- Lamps must be installed only in accordance with UNECE regulations
- Only mount the lamp to a flat, metal, dry, cleaned and degreased roof surface. The maximum speed of movement of the vehicle with a warning lamp attached with a magnet to the roof surface is 50km/h. Take special care in windy conditions. Do not unscrew the lamp, it will lose its water resistance.



www.myKAMAR.com

PHOTO AND TECHNICAL DRAWING:

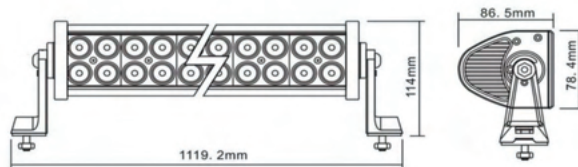

TECHNICAL SPECIFICATIONS:

MATERIAL	LED/LM QUANTITY	MOUNTING	WIRE	FUNCTION	WATT	VOLTAGE	CERTIFICATES	PACKING - BULK BOX
• Housing: AL • Lens: PC	• 80 LED • 4500 LM	• screws	• 250 mm	• work light • combo	• 240 W	• 12/24V	• ECE R10	• cart. dim.: 1096x110x100mm • weight: 3380g • 4 pcs/bulk box

We reserve the right to change technical data and any errors. Photos and specifications are for reference only, and the actual product may vary slightly. Reproduction in whole or parts of the catalog without written authorization is prohibited.



REFERENCE:
LB0030

PANEL LED 300W 100 LED

WARNINGS FOR THE USER:

- Do not look directly into the light - it may cause damage or even loss of vision.
- Install only in specialized workshops or professional services.
- Use in open space only.
- Use in accordance to the purpose.

INSTALLATION INSTRUCTIONS:

- It should be used exclusively in accordance with intended use.
- Mount exclusively in specialized workshops.
- The connection between the lamp and vehicle's installation should be isolated with heat-shrink tube, or, alternatively, with isolating tape, to avoid getting water and moisture to the copper wire of the lamp, which can damage electronic components. When it comes to lamp and plug, the plug should be mounted safely.
- Do not cut off tinned ends.
- Lamps must be installed only in accordance with UNECE regulations.
- Only mount the lamp to a flat, metal, dry, cleaned and degreased roof surface. The maximum speed of movement of the vehicle with a warning lamp attached with a magnet to the roof surface is 50km/h. Take special care in windy conditions. Do not unscrew the lamp, it will lose its water resistance.

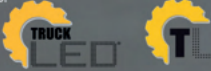

www.myKAMAR.com

PHOTO AND TECHNICAL DRAWING:

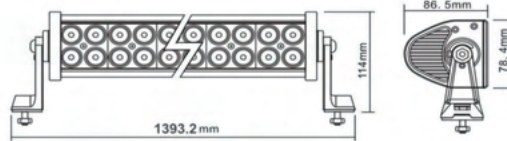

TECHNICAL SPECIFICATIONS:

MATERIAL	LED/LM QUANTITY	MOUNTING	WIRE	FUNCTION	WATT	VOLTAGE	CERTIFICATES	PACKING - BULK BOX
<ul style="list-style-type: none"> Housing: AL Lens: PC 	<ul style="list-style-type: none"> 100 LED 5307 LM 	<ul style="list-style-type: none"> screws 	<ul style="list-style-type: none"> 260 mm 	<ul style="list-style-type: none"> work light combo 	<ul style="list-style-type: none"> 300 W 	<ul style="list-style-type: none"> 12/24V 	<ul style="list-style-type: none"> ECE R10 	<ul style="list-style-type: none"> cart. dim.: 135 x 110 x 100mm weight: 3900g 4 pcs/bulk box

We reserve the right to change technical data and any errors. Photos and specifications are for reference only, and the actual product may vary slightly. Reproduction in whole or parts of the catalog without written authorization is prohibited.



REFERENCE:
LB0031F

PANEL LED 18W 98MM FLOOD

WARNINGS FOR THE USER:

- Do not look directly into the light - it may cause damage or even loss of vision.
- Install only in specialized workshops or professional services.
- Use in open space only.
- Use in accordance to the purpose.

INSTALLATION INSTRUCTIONS:

- It should be used exclusively in accordance with intended use.
- Mount exclusively in specialized workshops.
- The connection between the lamp and vehicle's installation should be isolated with heat-shrink tube or alternatively with isolating tape to avoid getting water and moisture to the copper wire of the lamp which can damage electronic components. When it comes to lamp and plug, the plug should be mounted safely.
- Do not cut off tinned ends.
- Lamps must be installed only in accordance with UNECE regulations.



www.myKAMAR.com

PHOTO AND TECHNICAL DRAWING:

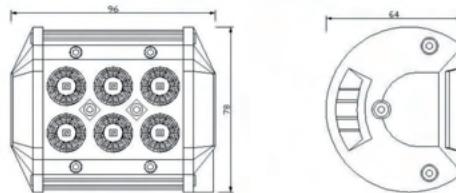

TECHNICAL SPECIFICATIONS:

MATERIAL	LED/LM QUANTITY	MOUNTING	WIRE	FUNCTION	WATT	VOLTAGE	CERTIFICATES	PACKING - BULK BOX
<ul style="list-style-type: none"> Housing: AL Lens: PC 	<ul style="list-style-type: none"> 6 LED 720 LM 	<ul style="list-style-type: none"> screws 	<ul style="list-style-type: none"> 300 mm 	<ul style="list-style-type: none"> work light combo 	<ul style="list-style-type: none"> 14 W 	<ul style="list-style-type: none"> 12/24V 	<ul style="list-style-type: none"> ECE R10 	<ul style="list-style-type: none"> cart. dim.: 100x90x90mm weight: 254g 40 pcs/bulk box

We reserve the right to change technical data and any errors. Photos and specifications are for reference only, and the actual product may vary slightly. Reproduction in whole or parts of the catalog without written authorization is prohibited.



REFERENCE:
LB0031S

PANEL LED 18W SPOT

WARNINGS FOR THE USER:

- Do not look directly into the light - it may cause damage or even loss of vision.
- Install only in specialized workshops or professional services.
- Use in open space only.
- Use in accordance to the purpose.

INSTALLATION INSTRUCTIONS:

- It should be used exclusively in accordance with intended use.
- Mount exclusively in specialized workshops.
- The connection between the lamp and vehicle's installation should be isolated with heat-shrink tube or alternatively with isolating tape to avoid getting water and moisture to the copper wire of the lamp which can damage electronic components. When it comes to lamp and plug, the plug should be mounted safely.
- Do not cut off tinned ends.
- Lamps must be installed only in accordance with UNECE regulations.



www.myKAMAR.com

PHOTO AND TECHNICAL DRAWING:

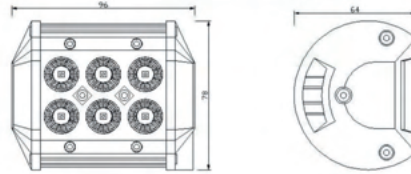
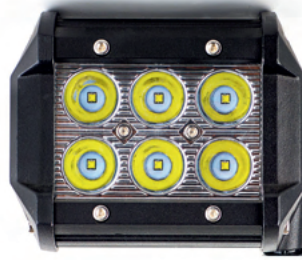

TECHNICAL SPECIFICATIONS:

MATERIAL	LED/LM QUANTITY	MOUNTING	WIRE	FUNCTION	WATT	VOLTAGE	CERTIFICATES	PACKING - BULK BOX
• Housing: PC • Lens: AL	• 6 LED • 720 LM	• screws	• 300 mm	• work light • combo	• 14 W	• 12/24V	• ECE R10	• cart. dim.: 100x90x90mm • weight: 284g • 40 pcs/bulk box

We reserve the right to change technical data and any errors. Photos and specifications are for reference only, and the actual product may vary slightly. Reproduction in whole or parts of the catalog without written authorization is prohibited.



REFERENCE:
LB0032F

PANEL LED 36W FLOOD

WARNINGS FOR THE USER:

- Do not look directly into the light - it may cause damage or even loss of vision.
- Install only in specialized workshops or professional services.
- Use in open space only.
- Use in accordance to the purpose.

INSTALLATION INSTRUCTIONS:

- It should be used exclusively in accordance with intended use.
- Mount exclusively in specialized workshops.
- The connection between the lamp and vehicle's installation should be isolated with heat-shrink tube or alternatively with isolating tape to avoid getting water and moisture to the copper wire of the lamp which can damage electronic components. When it comes to lamp and plug, the plug should be mounted safely.
- Do not cut off tinned ends.
- Lamps must be installed only in accordance with UNECE regulations.

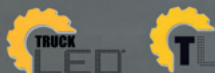

www.myKAMAR.com

PHOTO AND TECHNICAL DRAWING:

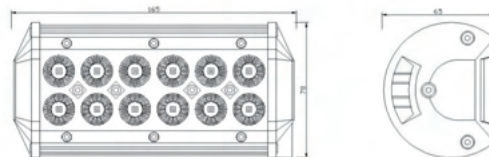

TECHNICAL SPECIFICATIONS:

MATERIAL	LED/LM QUANTITY	MOUNTING	WIRE	FUNCTION	WATT	VOLTAGE	CERTIFICATES	PACKING - BULK BOX
• Housing: AL • Lens: PC	• 12 LED • 1400 LM	• screws	• 300 mm	• work light • flood	• 24 W	• 12/24V	• ECE R10	• cart. dim.: 240x120x100mm • weight: 434g • 20 pcs/bulk box

We reserve the right to change technical data and any errors. Photos and specifications are for reference only, and the actual product may vary slightly. Reproduction in whole or parts of the catalog without written authorization is prohibited.



REFERENCE:
LB0032L

**PANEL LED 36W 167MM
COMBO LEFT**

WARNINGS FOR THE USER:

- Do not look directly into the light - it may cause damage or even loss of vision.
- Install only in specialized workshops or professional services.
- Use in open space only.
- Use in accordance to the purpose.

INSTALLATION INSTRUCTIONS:

- It should be used exclusively in accordance with intended use.
- Mount exclusively in specialized workshops.
- The connection between the lamp and vehicle's installation should be isolated with heat-shrink tube or alternatively with isolating tape to avoid getting water and moisture to the copper wire of the lamp which can damage electronic components. When it comes to lamp and plug, the plug should be mounted safely.
- Do not cut off tinned ends.
- Lamps must be installed only in accordance with UNECE regulations.



www.myKAMAR.com

PHOTO AND TECHNICAL DRAWING:

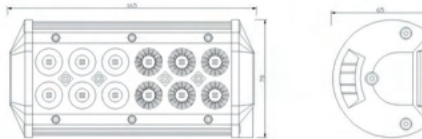

TECHNICAL SPECIFICATIONS:

MATERIAL	LED/LM QUANTITY	MOUNTING	WIRE	FUNCTION	WATT	VOLTAGE	CERTIFICATES	PACKING - BULK BOX
• Housing: AL • Lens: PC	• 12 LED • 1400 LM	• screws	• 300 mm	• work light • flood/spot	• 24 W	• 12/24V	• ECE R10	• cart. dim.: 240x120x100mm • weight: 434g • 20 pcs/bulk box

We reserve the right to change technical data and any errors. Photos and specifications are for reference only, and the actual product may vary slightly. Reproduction in whole or parts of the catalog without written authorization is prohibited.



REFERENCE:
LB0033

PANEL LED 72W 300MM

WARNINGS FOR THE USER:

- Do not look directly into the light - it may cause damage or even loss of vision.
- Install only in specialized workshops or professional services.
- Use in open space only.
- Use in accordance to the purpose.

INSTALLATION INSTRUCTIONS:

- It should be used exclusively in accordance with intended use.
- Mount exclusively in specialized workshops.
- The connection between the lamp and vehicle's installation should be isolated with heat-shrink tube or alternatively with isolating tape to avoid getting water and moisture to the copper wire of the lamp which can damage electronic components. When it comes to lamp and plug, the plug should be mounted safely.
- Do not cut off tinned ends.
- Lamps must be installed only in accordance with UNECE regulations.



www.myKAMAR.com

PHOTO AND TECHNICAL DRAWING:

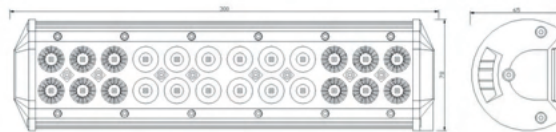
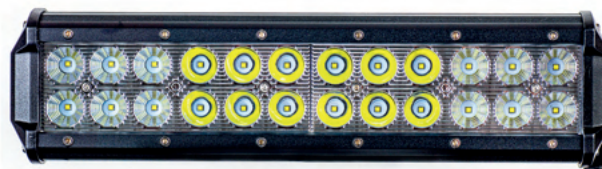

TECHNICAL SPECIFICATIONS:

MATERIAL	LED/LM QUANTITY	MOUNTING	WIRE	FUNCTION	WATT	VOLTAGE	CERTIFICATES	PACKING - BULK BOX
• Housing: AL • Lens: PC	• 24 LED • 2900 LM	• screws	• 300 mm	• work light • combo	• 54 W	• 12/24V	• ECE R10	• cart. dim.: 370x120x100mm • weight: 676g • 10 pcs/bulk box

We reserve the right to change technical data and any errors. Photos and specifications are for reference only, and the actual product may vary slightly. Reproduction in whole or parts of the catalog without written authorization is prohibited.



REFERENCE:
LB0034

PANEL LED 126W 505MM

WARNINGS FOR THE USER:

- Do not look directly into the light - it may cause damage or even loss of vision.
- Install only in specialized workshops or professional services.
- Use in open space only.
- Use in accordance to the purpose.

INSTALLATION INSTRUCTIONS:

- It should be used exclusively in accordance with intended use.
- Mount exclusively in specialized workshops.
- The connection between the lamp and vehicle's installation should be isolated with heat-shrink tube or alternatively with isolating tape to avoid getting water and moisture to the copper wire of the lamp which can damage electronic components. When it comes to lamp and plug, the plug should be mounted safely.
- Do not cut off tinned ends.
- Lamps must be installed only in accordance with UNECE regulations.



www.myKAMAR.com

PHOTO AND TECHNICAL DRAWING:

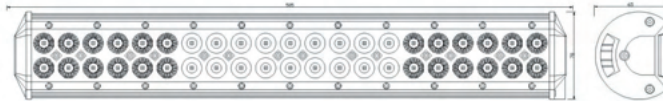
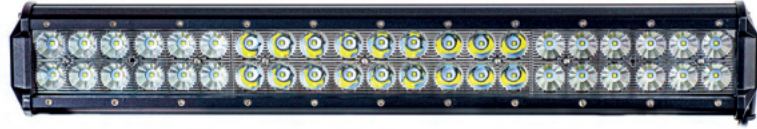

TECHNICAL SPECIFICATIONS:

MATERIAL	LED/LM QUANTITY	MOUNTING	WIRE	FUNCTION	WATT	VOLTAGE	CERTIFICATES	PACKING - BULK BOX
• Housing: AL • Lens: PC	• 42 LED • 6000 LM	• screws	• 300 mm	• work light • combo	• 93.5 W	• 12/24V	• ECE R10	• cart. dim.: 580x120x100mm • weight: 1077g • 8 pcs/bulk box

We reserve the right to change technical data and any errors. Photos and specifications are for reference only, and the actual product may vary slightly. Reproduction in whole or parts of the catalog without written authorization is prohibited.



REFERENCE:
LB0035

PANEL LED 180W

WARNINGS FOR THE USER:

- Do not look directly into the light - it may cause damage or even loss of vision.
- Install only in specialized workshops or professional services.
- Use in open space only.
- Use in accordance to the purpose.

INSTALLATION INSTRUCTIONS:

- It should be used exclusively in accordance with intended use.
- Mount exclusively in specialized workshops.
- The connection between the lamp and vehicle's installation should be isolated with heat-shrink tube or alternatively with isolating tape to avoid getting water and moisture to the copper wire of the lamp which can damage electronic components. When it comes to lamp and plug, the plug should be mounted safely.
- Do not cut off tinned ends.
- Lamps must be installed only in accordance with UNECE regulations.



www.myKAMAR.com

PHOTO AND TECHNICAL DRAWING:

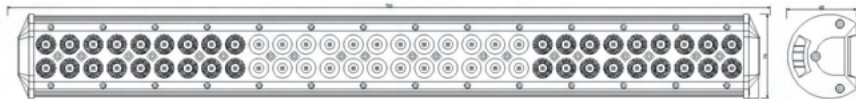

TECHNICAL SPECIFICATIONS:

MATERIAL	LED/LM QUANTITY	MOUNTING	WIRE	FUNCTION	WATT	VOLTAGE	CERTIFICATES	PACKING - BULK BOX
• Housing: AL • Lens: PC	• 60 LED • 7200 LM	• screws	• 300 mm	• work light • combo	• 113W	• 12/24V	• ECE R10	• cart. dim.: 800x120x100mm • weight: 1406g • 6 pcs/bulk box

We reserve the right to change technical data and any errors. Photos and specifications are for reference only, and the actual product may vary slightly. Reproduction in whole or parts of the catalog without written authorization is prohibited.



**REFERENCE:
LB00355**

PANEL LED 234W 915MM

WARNINGS FOR THE USER:

- Do not look directly into the light - it may cause damage or even loss of vision.
- Install only in specialized workshops or professional services.
- Use in open space only.
- Use in accordance to the purpose.

INSTALLATION INSTRUCTIONS:

- It should be used exclusively in accordance with intended use.
- Mount exclusively in specialized workshops.
- The connection between the lamp and vehicle's installation should be isolated with heat-shrink tube or alternatively with isolating tape to avoid getting water and moisture to the copper wire of the lamp which can damage electronic components. When it comes to lamp and plug, the plug should be mounted safely.
- Do not cut off tinned ends.
- Lamps must be installed only in accordance with UNECE regulations.



www.myKAMAR.com

PHOTO AND TECHNICAL DRAWING:

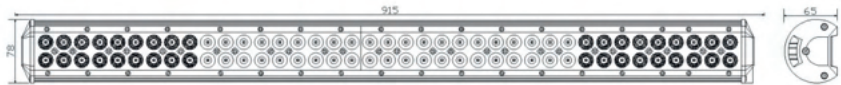

TECHNICAL SPECIFICATIONS:



MATERIAL	LED/LM QUANTITY	MOUNTING	WIRE	FUNCTION	WATT	VOLTAGE	CERTIFICATES	PACKING - BULK BOX
• Housing: AL • Lens: PC	• 78 LED • 13500 LM	• screws	• 300 mm	• work light • combo	• 160W	• 12/24V	• ECE R10	• cart. dim.: 130x115x1050mm • weight: 1800g • 6 pcs/bulk box

We reserve the right to change technical data and any errors. Photos and specifications are for reference only, and the actual product may vary slightly. Reproduction in whole or parts of the catalog without written authorization is prohibited.



**REFERENCE:
LB0036**

PANEL LED 288W 1118MM

WARNINGS FOR THE USER:

- Do not look directly into the light - it may cause damage or even loss of vision.
- Install only in specialized workshops or professional services.
- Use in open space only.
- Use in accordance to the purpose.

INSTALLATION INSTRUCTIONS:

- It should be used exclusively in accordance with intended use.
- Mount exclusively in specialized workshops.
- The connection between the lamp and vehicle's installation should be isolated with heat-shrink tube or alternatively with isolating tape to avoid getting water and moisture to the copper wire of the lamp which can damage electronic components. When it comes to lamp and plug, the plug should be mounted safely.
- Do not cut off tinned ends.
- Lamps must be installed only in accordance with UNECE regulations.



www.myKAMAR.com

PHOTO AND TECHNICAL DRAWING:

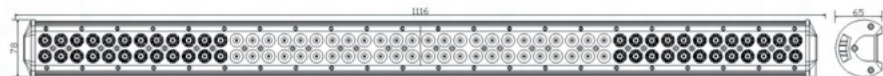

TECHNICAL SPECIFICATIONS:



MATERIAL	LED/LM QUANTITY	MOUNTING	WIRE	FUNCTION	WATT	VOLTAGE	CERTIFICATES	PACKING - BULK BOX
• Housing: AL • Lens: PC	• 96 LED • 11500 LM	• screws	• 300 mm	• work light • combo	• 197 W	• 12/24V	• ECE R10	• cart. dim.: 1200x120x100mm • weight: 2410g • 4 pcs/bulk box

We reserve the right to change technical data and any errors. Photos and specifications are for reference only, and the actual product may vary slightly. Reproduction in whole or parts of the catalog without written authorization is prohibited.



REFERENCE:
LB0039

LED PANEL LED 6X

WARNINGS FOR THE USER:

- Do not look directly into the light - it may cause damage or even loss of vision.
- Install only in specialized workshops or professional services.
- Use in open space only.
- Use in accordance to the purpose.

INSTALLATION INSTRUCTIONS:

- It should be used exclusively in accordance with intended use.
- Mount exclusively in specialized workshops.
- The connection between the lamp and vehicle's installation should be isolated with heat-shrink tube or alternatively with isolating tape to avoid getting water and moisture to the copper wire of the lamp which can damage electronic components. When it comes to lamp and plug, the plug should be mounted safely.
- Do not cut off tinned ends.
- Lamps must be installed only in accordance with UNECE regulations.



www.myKAMAR.com

PHOTO AND TECHNICAL DRAWING:

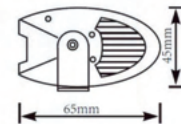
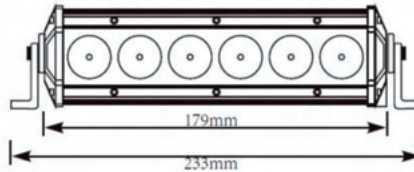

TECHNICAL SPECIFICATIONS:

MATERIAL	LED/LM QUANTITY	MOUNTING	WIRE	FUNCTION	WATT	VOLTAGE	CERTIFICATES	PACKING - BULK BOX
• Housing: AL • Lens: PC	• 6 LED • 850 LM	• screws	• 250 mm	• work light • flood	• 30 W	• 12/24V	• ECE R10	• cart. dim.: 210x100x90mm • weight: 550g • 20 pcs/bulk box

We reserve the right to change technical data and any errors. Photos and specifications are for reference only, and the actual product may vary slightly. Reproduction in whole or parts of the catalog without written authorization is prohibited.



REFERENCE:
LB0039S

PANEL LED 6X LED SPOT

WARNINGS FOR THE USER:

- Do not look directly into the light - it may cause damage or even loss of vision.
- Install only in specialized workshops or professional services.
- Use in open space only.
- Use in accordance to the purpose.

INSTALLATION INSTRUCTIONS:

- It should be used exclusively in accordance with intended use.
- Mount exclusively in specialized workshops.
- The connection between the lamp and vehicle's installation should be isolated with heat-shrink tube or alternatively with isolating tape to avoid getting water and moisture to the copper wire of the lamp which can damage electronic components. When it comes to lamp and plug, the plug should be mounted safely.
- Do not cut off tinned ends.
- Lamps must be installed only in accordance with UNECE regulations.



www.myKAMAR.com

PHOTO AND TECHNICAL DRAWING:

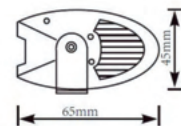
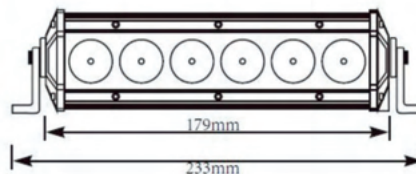

TECHNICAL SPECIFICATIONS:

MATERIAL	LED/LM QUANTITY	MOUNTING	WIRE	FUNCTION	WATT	VOLTAGE	CERTIFICATES	PACKING - BULK BOX
• Housing: PC • Lens: AL	• 6 LED • 850 LM	• screws	• 250 mm	• work light • spot	• 30W	• 12/24V	• ECE R10	• cart. dim.: 210x100x90mm • weight: 550g • 20 pcs/bulk box

We reserve the right to change technical data and any errors. Photos and specifications are for reference only, and the actual product may vary slightly. Reproduction in whole or parts of the catalog without written authorization is prohibited.



REFERENCE:
LB0042

PANEL LED X 12 QUAD

WARNINGS FOR THE USER:

- Do not look directly into the light - it may cause damage or even loss of vision.
- Install only in specialized workshops or professional services.
- Use in open space only.
- Use in accordance to the purpose.

INSTALLATION INSTRUCTIONS:

- It should be used exclusively in accordance with intended use.
- Mount exclusively in specialized workshops.
- The connection between the lamp and vehicle's installation should be isolated with heat-shrink tube or alternatively with isolating tape to avoid getting water and moisture to the copper wire of the lamp which can damage electronic components. When it comes to lamp and plug, the plug should be mounted safely.
- Do not cut off tinned ends.
- Lamps must be installed only in accordance with UNECE regulations.



www.myKAMAR.com

PHOTO AND TECHNICAL DRAWING:

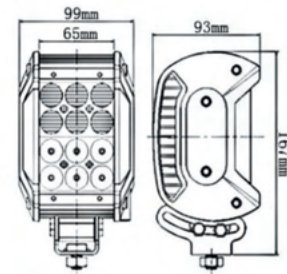

TECHNICAL SPECIFICATIONS:

MATERIAL	LED/LM QUANTITY	MOUNTING	WIRE	FUNCTION	WATT	VOLTAGE	CERTIFICATES	PACKING - BULK BOX
• Housing: AL • Lens: PC	• 12 LED • 1749 LM	• screws	• 250 mm	• work light • combo	• 36W	• 12/24V	• ECE R10	• cart. dim.: 170x110x100mm • weight: 1110g • 20 pcs/bulk box

We reserve the right to change technical data and any errors. Photos and specifications are for reference only, and the actual product may vary slightly. Reproduction in whole or parts of the catalog without written authorization is prohibited.



REFERENCE:
LB0043

PANEL LED 72W QUAD

WARNINGS FOR THE USER:

- Do not look directly into the light - it may cause damage or even loss of vision.
- Install only in specialized workshops or professional services.
- Use in open space only.
- Use in accordance to the purpose.

INSTALLATION INSTRUCTIONS:

- It should be used exclusively in accordance with intended use.
- Mount exclusively in specialized workshops.
- The connection between the lamp and vehicle's installation should be isolated with heat-shrink tube or alternatively with isolating tape to avoid getting water and moisture to the copper wire of the lamp which can damage electronic components. When it comes to lamp and plug, the plug should be mounted safely.
- Do not cut off tinned ends.
- Lamps must be installed only in accordance with UNECE regulations.



www.myKAMAR.com

PHOTO AND TECHNICAL DRAWING:

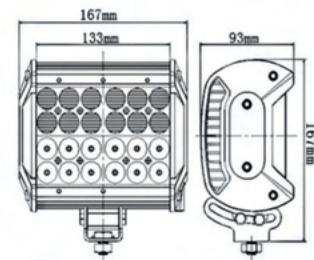

TECHNICAL SPECIFICATIONS:

MATERIAL	LED/LM QUANTITY	MOUNTING	WIRE	FUNCTION	WATT	VOLTAGE	CERTIFICATES	PACKING - BULK BOX
• Housing: AL • Lens: PC	• 24 LED • 3767 LM	• screws	• 250 mm	• work light • combo	• 72W	• 12/24V	• ECE R10	• cart. dim.: 240x190x160mm • weight: 1700g • 8 pcs/bulk box

We reserve the right to change technical data and any errors. Photos and specifications are for reference only, and the actual product may vary slightly. Reproduction in whole or parts of the catalog without written authorization is prohibited.



REFERENCE:
LB0044

PANEL LED 108W QUAD

WARNINGS FOR THE USER:

- Do not look directly into the light - it may cause damage or even loss of vision.
- Install only in specialized workshops or professional services.
- Use in open space only.
- Use in accordance to the purpose.

INSTALLATION INSTRUCTIONS:

- It should be used exclusively in accordance with intended use.
- Mount exclusively in specialized workshops.
- The connection between the lamp and vehicle's installation should be isolated with heat-shrink tube or alternatively with isolating tape to avoid getting water and moisture to the copper wire of the lamp which can damage electronic components. When it comes to lamp and plug, the plug should be mounted safely.
- Do not cut off tinned ends.
- Lamps must be installed only in accordance with UNECE regulations.



www.myKAMAR.com

PHOTO AND TECHNICAL DRAWING:



TECHNICAL SPECIFICATIONS:

MATERIAL	LED/LM QUANTITY	MOUNTING	WIRE	FUNCTION	WATT	VOLTAGE	CERTIFICATES	PACKING - BULK BOX
• Housing: AL • Lens: PC	• 36 LED • 5032 LM	• screws	• 250 mm	• work light • combo	• 108W	• 12/24V	• ECE R10	• cart. dim.: 310x190x160mm • weight: 2600g • 6 pcs/bulk box

We reserve the right to change technical data and any errors. Photos and specifications are for reference only, and the actual product may vary slightly. Reproduction in whole or parts of the catalog without written authorization is prohibited.



REFERENCE:
LB0045

PANEL LED 144W QUAD

WARNINGS FOR THE USER:

- Do not look directly into the light - it may cause damage or even loss of vision.
- Install only in specialized workshops or professional services.
- Use in open space only.
- Use in accordance to the purpose.

INSTALLATION INSTRUCTIONS:

- It should be used exclusively in accordance with intended use.
- Mount exclusively in specialized workshops.
- The connection between the lamp and vehicle's installation should be isolated with heat-shrink tube or alternatively with isolating tape to avoid getting water and moisture to the copper wire of the lamp which can damage electronic components. When it comes to lamp and plug, the plug should be mounted safely.
- Do not cut off tinned ends.
- Lamps must be installed only in accordance with UNECE regulations.

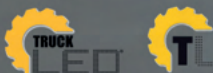

www.myKAMAR.com

PHOTO AND TECHNICAL DRAWING:



TECHNICAL SPECIFICATIONS:

MATERIAL	LED/LM QUANTITY	MOUNTING	WIRE	FUNCTION	WATT	VOLTAGE	CERTIFICATES	PACKING - BULK BOX
• Housing: AL • Lens: PC	• 48 LED • 6473 LM	• screws	• 250 mm	• work light • combo	• 144W	• 12/24V	• ECE R10	• cart. dim.: 360x190x160mm • weight: 3200g • 6 pcs/bulk box

We reserve the right to change technical data and any errors. Photos and specifications are for reference only, and the actual product may vary slightly. Reproduction in whole or parts of the catalog without written authorization is prohibited.



REFERENCE:
LB0046

PANEL LED 180W QUAD

WARNINGS FOR THE USER:

- Do not look directly into the light - it may cause damage or even loss of vision.
- Install only in specialized workshops or professional services.
- Use in open space only.
- Use in accordance to the purpose.

INSTALLATION INSTRUCTIONS:

- It should be used exclusively in accordance with intended use.
- Mount exclusively in specialized workshops.
- The connection between the lamp and vehicle's installation should be isolated with heat-shrink tube or alternatively with isolating tape to avoid getting water and moisture to the copper wire of the lamp which can damage electronic components. When it comes to lamp and plug, the plug should be mounted safely.
- Do not cut off tinned ends.
- Lamps must be installed only in accordance with UNECE regulations.



www.myKAMAR.com

PHOTO AND TECHNICAL DRAWING:

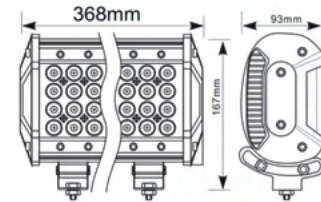

TECHNICAL SPECIFICATIONS:

MATERIAL	LED/LM QUANTITY	MOUNTING	WIRE	FUNCTION	WATT	VOLTAGE	CERTIFICATES	PACKING - BULK BOX
• Housing: AL • Lens: PC	• 60 LED • 7056 LM	• screws	• 250 mm	• work light • combo	• 180W	• 12/24V	• ECE R10	• cart. dim.: 440x180x145mm • weight: 3400g • 8 pcs/bulk box

We reserve the right to change technical data and any errors. Photos and specifications are for reference only, and the actual product may vary slightly. Reproduction in whole or parts of the catalog without written authorization is prohibited.



REFERENCE:
LB0058

PANEL LED 12X LED COMBO

WARNINGS FOR THE USER:

- Do not look directly into the light - it may cause damage or even loss of vision.
- Install only in specialized workshops or professional services.
- Use in open space only.
- Use in accordance to the purpose.

INSTALLATION INSTRUCTIONS:

- It should be used exclusively in accordance with intended use.
- Mount exclusively in specialized workshops.
- The connection between the lamp and vehicle's installation should be isolated with heat-shrink tube or alternatively with isolating tape to avoid getting water and moisture to the copper wire of the lamp which can damage electronic components. When it comes to lamp and plug, the plug should be mounted safely.
- Do not cut off tinned ends.
- Lamps must be installed only in accordance with UNECE regulations.



www.myKAMAR.com

PHOTO AND TECHNICAL DRAWING:

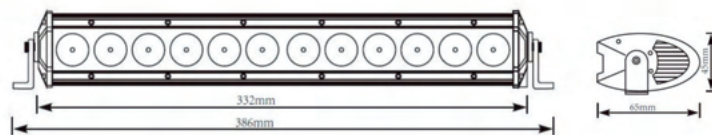

TECHNICAL SPECIFICATIONS:

MATERIAL	LED/LM QUANTITY	MOUNTING	WIRE	FUNCTION	WATT	VOLTAGE	CERTIFICATES	PACKING - BULK BOX
• Housing: AL • Lens: PC	• 12 LED • 1660 LM	• screws	• 250 mm	• work light • combo	• 60W	• 12/24V	• ECE R10	• cart. dim.: 420x110x110mm • weight: 1400g • 10 pcs/bulk box

We reserve the right to change technical data and any errors. Photos and specifications are for reference only, and the actual product may vary slightly. Reproduction in whole or parts of the catalog without written authorization is prohibited.



REFERENCE:
LB0059

LED PANEL LED 18X COMBO

WARNINGS FOR THE USER:

- Do not look directly into the light - it may cause damage or even loss of vision.
- Install only in specialized workshops or professional services.
- Use in open space only.
- Use in accordance to the purpose.

INSTALLATION INSTRUCTIONS:

- It should be used exclusively in accordance with intended use.
- Mount exclusively in specialized workshops.
- The connection between the lamp and vehicle's installation should be isolated with heat-shrink tube or alternatively with isolating tape to avoid getting water and moisture to the copper wire of the lamp which can damage electronic components. When it comes to lamp and plug, the plug should be mounted safely.
- Do not cut off tinned ends.
- Lamps must be installed only in accordance with UNECE regulations.



www.myKAMAR.com

PHOTO AND TECHNICAL DRAWING:

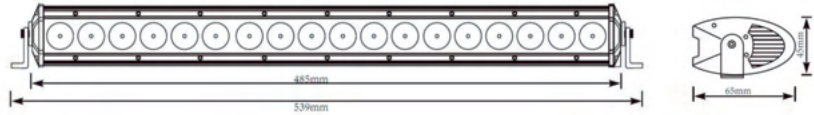

TECHNICAL SPECIFICATIONS:

MATERIAL	LED/LM QUANTITY	MOUNTING	WIRE	FUNCTION	WATT	VOLTAGE	CERTIFICATES	PACKING - BULK BOX
• Housing: AL • Lens: PC	• 18 LED • 3030 LM	• screws	• 250 mm	• work light • combo	• 90 W	• 12/24V	• ECE R10	• cart. dim.: 580x110x110mm • weight: 1900g • 4 pcs/bulk box

We reserve the right to change technical data and any errors. Photos and specifications are for reference only, and the actual product may vary slightly. Reproduction in whole or parts of the catalog without written authorization is prohibited.



REFERENCE:
LB0060

PANEL LED 24X LED COMBO

WARNINGS FOR THE USER:

- Do not look directly into the light - it may cause damage or even loss of vision.
- Install only in specialized workshops or professional services.
- Use in open space only.
- Use in accordance to the purpose.

INSTALLATION INSTRUCTIONS:

- It should be used exclusively in accordance with intended use.
- Mount exclusively in specialized workshops.
- The connection between the lamp and vehicle's installation should be isolated with heat-shrink tube or alternatively with isolating tape to avoid getting water and moisture to the copper wire of the lamp which can damage electronic components. When it comes to lamp and plug, the plug should be mounted safely.
- Do not cut off tinned ends.
- Lamps must be installed only in accordance with UNECE regulations.

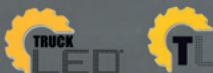

www.myKAMAR.com

PHOTO AND TECHNICAL DRAWING:

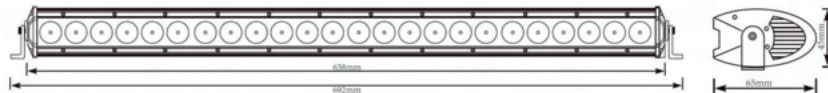

TECHNICAL SPECIFICATIONS:

MATERIAL	LED/LM QUANTITY	MOUNTING	WIRE	FUNCTION	WATT	VOLTAGE	CERTIFICATES	PACKING - BULK BOX
• Housing: AL • Lens: PC	• 24 LED • 4123 LM	• screws	• 250 mm	• work light • combo	• 120W	• 12/24V	• ECE R10	• cart. dim.: 720x110x110mm • weight: 2600g • 4 pcs/bulk box

We reserve the right to change technical data and any errors. Photos and specifications are for reference only, and the actual product may vary slightly. Reproduction in whole or parts of the catalog without written authorization is prohibited.



REFERENCE:
LB0061

LED PANEL LED 36X COMBO

WARNINGS FOR THE USER:

- Do not look directly into the light - it may cause damage or even loss of vision.
- Install only in specialized workshops or professional services.
- Use in open space only.
- Use in accordance to the purpose.

INSTALLATION INSTRUCTIONS:

- It should be used exclusively in accordance with intended use.
- Mount exclusively in specialized workshops.
- The connection between the lamp and vehicle's installation should be isolated with heat-shrink tube or alternatively with isolating tape to avoid getting water and moisture to the copper wire of the lamp which can damage electronic components. When it comes to lamp and plug, the plug should be mounted safely.
- Do not cut off tinned ends.
- Lamps must be installed only in accordance with UNECE regulations.



www.myKAMAR.com

PHOTO AND TECHNICAL DRAWING:

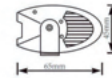
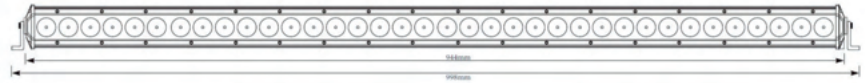

TECHNICAL SPECIFICATIONS:

MATERIAL	LED/LM QUANTITY	MOUNTING	WIRE	FUNCTION	WATT	VOLTAGE	CERTIFICATES	PACKING - BULK BOX
• Housing: AL • Lens: PC	• 36 LED • 6373 LM	• screws	• 250 mm	• work light • combo	• 180W	• 12/24V	• ECE R10	• cart. dim.: 1020x110x110mm • weight: 3400g • 4 pcs/bulk box

We reserve the right to change technical data and any errors. Photos and specifications are for reference only, and the actual product may vary slightly. Reproduction in whole or parts of the catalog without written authorization is prohibited.



REFERENCE:
LB0063

PANEL LED 10X LED

WARNINGS FOR THE USER:

- Do not look directly into the light - it may cause damage or even loss of vision.
- Install only in specialized workshops or professional services.
- Use in open space only.
- Use in accordance to the purpose.

INSTALLATION INSTRUCTIONS:

- It should be used exclusively in accordance with intended use.
- Mount exclusively in specialized workshops.
- The connection between the lamp and vehicle's installation should be isolated with heat-shrink tube or alternatively with isolating tape to avoid getting water and moisture to the copper wire of the lamp which can damage electronic components. When it comes to lamp and plug, the plug should be mounted safely.
- Do not cut off tinned ends.
- Lamps must be installed only in accordance with UNECE regulations.



www.myKAMAR.com

PHOTO AND TECHNICAL DRAWING:

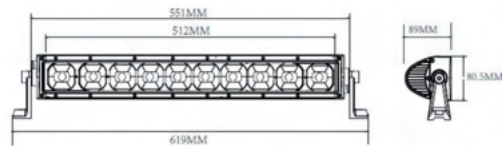

TECHNICAL SPECIFICATIONS:

MATERIAL	LED/LM QUANTITY	MOUNTING	WIRE	FUNCTION	WATT	VOLTAGE	CERTIFICATES	PACKING - BULK BOX
• Housing: AL • Lens: PC	• 10 LED • 4469 LM	• screws	• 250 mm	• work light • combo	• 120W	• 12/24V	• ECE R10	• cart. dim.: 680x120x120mm • weight: 2700g • 4 pcs/bulk box

We reserve the right to change technical data and any errors. Photos and specifications are for reference only, and the actual product may vary slightly. Reproduction in whole or parts of the catalog without written authorization is prohibited.



REFERENCE:
LB0064

PANEL LED 15X LED

WARNINGS FOR THE USER:

- Do not look directly into the light - it may cause damage or even loss of vision.
- Install only in specialized workshops or professional services.
- Use in open space only.
- Use in accordance to the purpose.

INSTALLATION INSTRUCTIONS:

- It should be used exclusively in accordance with intended use.
- Mount exclusively in specialized workshops.
- The connection between the lamp and vehicle's installation should be isolated with heat-shrink tube or alternatively with isolating tape to avoid getting water and moisture to the copper wire of the lamp which can damage electronic components. When it comes to lamp and plug, the plug should be mounted safely.
- Do not cut off tinned ends.
- Lamps must be installed only in accordance with UNECE regulations.



www.myKAMAR.com

PHOTO AND TECHNICAL DRAWING:

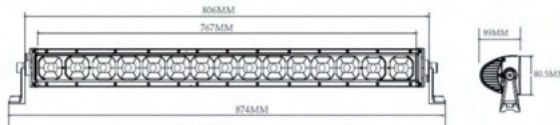

TECHNICAL SPECIFICATIONS:

MATERIAL	LED/LM QUANTITY	MOUNTING	WIRE	FUNCTION	WATT	VOLTAGE	CERTIFICATES	PACKING - BULK BOX
• Housing: AL • Lens: PC	• 15 LED • 7045 LM	• screws	• 250 mm	• work light • combo	• 180W	• 12/24V	• ECE R10	• cart. dim.: 930x120x120mm • weight: 3800g • 4 pcs/bulk box

We reserve the right to change technical data and any errors. Photos and specifications are for reference only, and the actual product may vary slightly. Reproduction in whole or parts of the catalog without written authorization is prohibited.



REFERENCE:
LB0065

PANEL LED 20X LED

WARNINGS FOR THE USER:

- Do not look directly into the light - it may cause damage or even loss of vision.
- Install only in specialized workshops or professional services.
- Use in open space only.
- Use in accordance to the purpose.

INSTALLATION INSTRUCTIONS:

- It should be used exclusively in accordance with intended use.
- Mount exclusively in specialized workshops.
- The connection between the lamp and vehicle's installation should be isolated with heat-shrink tube or alternatively with isolating tape to avoid getting water and moisture to the copper wire of the lamp which can damage electronic components. When it comes to lamp and plug, the plug should be mounted safely.
- Do not cut off tinned ends.
- Lamps must be installed only in accordance with UNECE regulations.



www.myKAMAR.com

PHOTO AND TECHNICAL DRAWING:

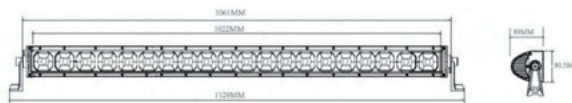

TECHNICAL SPECIFICATIONS:

MATERIAL	LED/LM QUANTITY	MOUNTING	WIRE	FUNCTION	WATT	VOLTAGE	CERTIFICATES	PACKING - BULK BOX
• Housing: AL • Lens: PC	• 20 LED • 8290 LM	• screws	• 250 mm	• work light • combo	• 240W	• 12/24V	• ECE R10	• cart. dim.: 1210x120x120mm • weight: 5000g • 4 pcs/bulk box

We reserve the right to change technical data and any errors. Photos and specifications are for reference only, and the actual product may vary slightly. Reproduction in whole or parts of the catalog without written authorization is prohibited.



REFERENCE:
LB0068

LED PANEL 4X LED

WARNINGS FOR THE USER:

- Do not look directly into the light - it may cause damage or even loss of vision.
- Install only in specialized workshops or professional services.
- Use in open space only.
- Use in accordance to the purpose.

INSTALLATION INSTRUCTIONS:

- It should be used exclusively in accordance with intended use.
- Mount exclusively in specialized workshops.
- The connection between the lamp and vehicle's installation should be isolated with heat-shrink tube or alternatively with isolating tape to avoid getting water and moisture to the copper wire of the lamp which can damage electronic components. When it comes to lamp and plug, the plug should be mounted safely.
- Do not cut off tinned ends.
- Lamps must be installed only in accordance with UNECE regulations.



www.myKAMAR.com

PHOTO AND TECHNICAL DRAWING:

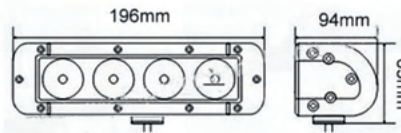

TECHNICAL SPECIFICATIONS:

MATERIAL	LED/LM QUANTITY	MOUNTING	WIRE	FUNCTION	WATT	VOLTAGE	CERTIFICATES	PACKING - BULK BOX
• Housing: AL • Lens: PC	• 4 LED • 1300 LM	• screws	• 500 mm	• work light • spot	• 30 W	• 12/24V	• ECE R10	• cart. dim.: 590x140x120mm • weight: 1150g • 12 pcs/bulk box

We reserve the right to change technical data and any errors. Photos and specifications are for reference only, and the actual product may vary slightly. Reproduction in whole or parts of the catalog without written authorization is prohibited.



REFERENCE:
LB0069

LED PANEL 8X LED

WARNINGS FOR THE USER:

- Do not look directly into the light - it may cause damage or even loss of vision.
- Install only in specialized workshops or professional services.
- Use in open space only.
- Use in accordance to the purpose.

INSTALLATION INSTRUCTIONS:

- It should be used exclusively in accordance with intended use.
- Mount exclusively in specialized workshops.
- The connection between the lamp and vehicle's installation should be isolated with heat-shrink tube or alternatively with isolating tape to avoid getting water and moisture to the copper wire of the lamp which can damage electronic components. When it comes to lamp and plug, the plug should be mounted safely.
- Do not cut off tinned ends.
- Lamps must be installed only in accordance with UNECE regulations.



www.myKAMAR.com

PHOTO AND TECHNICAL DRAWING:

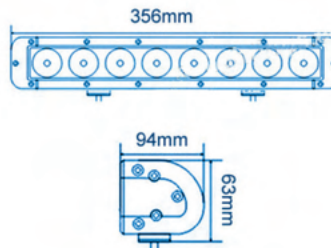

TECHNICAL SPECIFICATIONS:

MATERIAL	LED/LM QUANTITY	MOUNTING	WIRE	FUNCTION	WATT	VOLTAGE	CERTIFICATES	PACKING - BULK BOX
• Housing: AL • Lens: PC	• 8 LED • 2600 LM	• screws	• 500 mm	• work light • combo	• 50 W	• 12/24V	• ECE R10	• cart. dim.: 940x140x120mm • weight: 2100g • 8 pcs/bulk box

We reserve the right to change technical data and any errors. Photos and specifications are for reference only, and the actual product may vary slightly. Reproduction in whole or parts of the catalog without written authorization is prohibited.



**REFERENCE:
LB0070**

LED PANEL 12X LED 1

WARNINGS FOR THE USER:

- Do not look directly into the light - it may cause damage or even loss of vision.
- Install only in specialized workshops or professional services.
- Use in open space only.
- Use in accordance to the purpose.

INSTALLATION INSTRUCTIONS:

- It should be used exclusively in accordance with intended use.
- Mount exclusively in specialized workshops.
- The connection between the lamp and vehicle's installation should be isolated with heat-shrink tube or alternatively with isolating tape to avoid getting water and moisture to the copper wire of the lamp which can damage electronic components. When it comes to lamp and plug, the plug should be mounted safely.
- Do not cut off tinned ends.
- Lamps must be installed only in accordance with UNECE regulations.



www.myKAMAR.com

PHOTO AND TECHNICAL DRAWING:

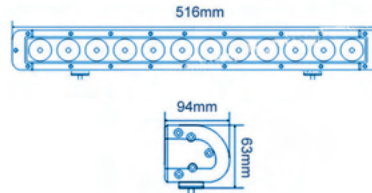

TECHNICAL SPECIFICATIONS:

MATERIAL	LED/LM QUANTITY	MOUNTING	WIRE	FUNCTION	WATT	VOLTAGE	CERTIFICATES	PACKING - BULK BOX
• Housing: AL • Lens: PC	• 12 LED • 3900 LM	• screws	• 500 mm	• work light • combo	• 88 W	• 12/24V	• ECE R10	• cart. dim.: 555x140x120mm • weight: 2480g • 4 pcs/bulk box

We reserve the right to change technical data and any errors. Photos and specifications are for reference only, and the actual product may vary slightly. Reproduction in whole or parts of the catalog without written authorization is prohibited.



**REFERENCE:
LB0071**

LED PANEL 18X LED

WARNINGS FOR THE USER:

- Do not look directly into the light - it may cause damage or even loss of vision.
- Install only in specialized workshops or professional services.
- Use in open space only.
- Use in accordance to the purpose.

INSTALLATION INSTRUCTIONS:

- It should be used exclusively in accordance with intended use.
- Mount exclusively in specialized workshops.
- The connection between the lamp and vehicle's installation should be isolated with heat-shrink tube or alternatively with isolating tape to avoid getting water and moisture to the copper wire of the lamp which can damage electronic components. When it comes to lamp and plug, the plug should be mounted safely.
- Do not cut off tinned ends.
- Lamps must be installed only in accordance with UNECE regulations.

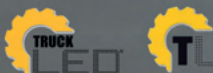

www.myKAMAR.com

PHOTO AND TECHNICAL DRAWING:

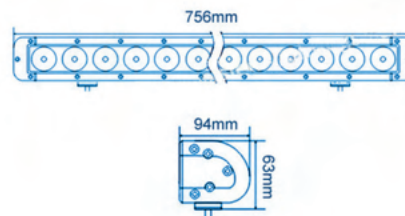

TECHNICAL SPECIFICATIONS:

MATERIAL	LED/LM QUANTITY	MOUNTING	WIRE	FUNCTION	WATT	VOLTAGE	CERTIFICATES	PACKING - BULK BOX
• Housing: AL • Lens: PC	• 18 LED • 5850 LM	• screws	• 500 mm	• work light • combo	• 132W	• 12/24V	• ECE R10	• cart. dim.: 940x140x120mm • weight: 3550g • 4 pcs/bulk box

We reserve the right to change technical data and any errors. Photos and specifications are for reference only, and the actual product may vary slightly. Reproduction in whole or parts of the catalog without written authorization is prohibited.



**REFERENCE:
LB0072**

PANEL LED 26 X LED

WARNINGS FOR THE USER:

- Do not look directly into the light - it may cause damage or even loss of vision.
- Install only in specialized workshops or professional services.
- Use in open space only.
- Use in accordance to the purpose.

INSTALLATION INSTRUCTIONS:

- It should be used exclusively in accordance with intended use.
- Mount exclusively in specialized workshops.
- The connection between the lamp and vehicle's installation should be isolated with heat-shrink tube or alternatively with isolating tape to avoid getting water and moisture to the copper wire of the lamp which can damage electronic components. When it comes to lamp and plug, the plug should be mounted safely.
- Do not cut off tinned ends.
- Lamps must be installed only in accordance with UNECE regulations.



www.myKAMAR.com

PHOTO AND TECHNICAL DRAWING:

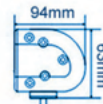
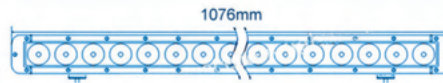

TECHNICAL SPECIFICATIONS:

MATERIAL	LED/LM QUANTITY	MOUNTING	WIRE	FUNCTION	WATT	VOLTAGE	CERTIFICATES	PACKING - BULK BOX
• Housing: AL • Lens: PC	• 26 LED • 8450 LM	• screws	• 600 mm	• work light • combo	• 180 W	• 12/24V	• ECE R10	• cart. dim.: 1170x140x120mm • weight: 4730g • 4 pcs/bulk box

We reserve the right to change technical data and any errors. Photos and specifications are for reference only, and the actual product may vary slightly. Reproduction in whole or parts of the catalog without written authorization is prohibited.



**REFERENCE:
LB0073**

PANEL LED 6X LED

WARNINGS FOR THE USER:

- Do not look directly into the light - it may cause damage or even loss of vision.
- Install only in specialized workshops or professional services.
- Use in open space only.
- Use in accordance to the purpose.

INSTALLATION INSTRUCTIONS:

- It should be used exclusively in accordance with intended use.
- Mount exclusively in specialized workshops.
- The connection between the lamp and vehicle's installation should be isolated with heat-shrink tube or alternatively with isolating tape to avoid getting water and moisture to the copper wire of the lamp which can damage electronic components. When it comes to lamp and plug, the plug should be mounted safely.
- Do not cut off tinned ends.
- Lamps must be installed only in accordance with UNECE regulations.

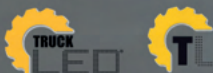

www.myKAMAR.com

PHOTO AND TECHNICAL DRAWING:

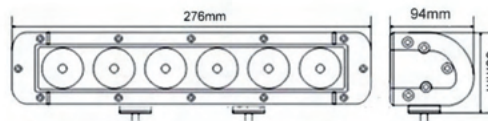

TECHNICAL SPECIFICATIONS:

MATERIAL	LED/LM QUANTITY	MOUNTING	WIRE	FUNCTION	WATT	VOLTAGE	CERTIFICATES	PACKING - BULK BOX
• Housing: AL • Lens: PC	• 6 LED • 1950 LM	• screws	• 600 mm	• work light • flood	• 48W	• 12/24V	• ECE R10	• cart. dim.: 590x140x120mm • weight: 1950g • 12 pcs/bulk box

We reserve the right to change technical data and any errors. Photos and specifications are for reference only, and the actual product may vary slightly. Reproduction in whole or parts of the catalog without written authorization is prohibited.



REFERENCE:
LB0074

PANEL LED 18XLED SPOT

WARNINGS FOR THE USER:

- Do not look directly into the light - it may cause damage or even loss of vision.
- Install only in specialized workshops or professional services.
- Use in open space only.
- Use in accordance to the purpose.

INSTALLATION INSTRUCTIONS:

- It should be used exclusively in accordance with intended use.
- Mount exclusively in specialized workshops.
- The connection between the lamp and vehicle's installation should be isolated with heat-shrink tube or alternatively with isolating tape to avoid getting water and moisture to the copper wire of the lamp which can damage electronic components. When it comes to lamp and plug, the plug should be mounted safely.
- Do not cut off tinned ends.
- Lamps must be installed only in accordance with UNECE regulations.



www.myKAMAR.com

PHOTO AND TECHNICAL DRAWING:

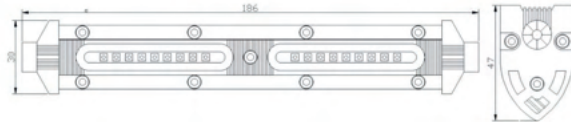

TECHNICAL SPECIFICATIONS:



MATERIAL	LED/LM QUANTITY	MOUNTING	WIRE	FUNCTION	WATT	VOLTAGE	CERTIFICATES	PACKING - BULK BOX
• Housing: AL • Lens: PC	• 18 LED • 1200 LM	• screws	• 300 mm	• work light • spot	• 27W	• 12/24V	• ECE R10	• cart. dim.: 55x45x200mm • weight: 215g • 50 pcs/bulk box

We reserve the right to change technical data and any errors. Photos and specifications are for reference only, and the actual product may vary slightly. Reproduction in whole or parts of the catalog without written authorization is prohibited.



REFERENCE:
LB0075

LED PANEL 24XLED SPOT

WARNINGS FOR THE USER:

- Do not look directly into the light - it may cause damage or even loss of vision.
- Install only in specialized workshops or professional services.
- Use in open space only.
- Use in accordance to the purpose.

INSTALLATION INSTRUCTIONS:

- It should be used exclusively in accordance with intended use.
- Mount exclusively in specialized workshops.
- The connection between the lamp and vehicle's installation should be isolated with heat-shrink tube or alternatively with isolating tape to avoid getting water and moisture to the copper wire of the lamp which can damage electronic components. When it comes to lamp and plug, the plug should be mounted safely.
- Do not cut off tinned ends.
- Lamps must be installed only in accordance with UNECE regulations.

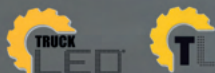

www.myKAMAR.com

PHOTO AND TECHNICAL DRAWING:

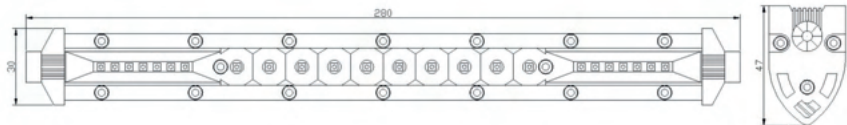

TECHNICAL SPECIFICATIONS:



MATERIAL	LED/LM QUANTITY	MOUNTING	WIRE	FUNCTION	WATT	VOLTAGE	CERTIFICATES	PACKING - BULK BOX
• Housing: AL • Lens: PC	• 24 LED • 1600 LM	• screws	• 300 mm	• work light • spot	• 30W	• 12/24V	• ECE R10	• cart. dim.: 55x45x300mm • weight: 325g • 50 pcs/bulk box

We reserve the right to change technical data and any errors. Photos and specifications are for reference only, and the actual product may vary slightly. Reproduction in whole or parts of the catalog without written authorization is prohibited.



REFERENCE:
LB0076

PANEL LED 60XLED

WARNINGS FOR THE USER:

- Do not look directly into the light - it may cause damage or even loss of vision.
- Install only in specialized workshops or professional services.
- Use in open space only.
- Use in accordance to the purpose.

INSTALLATION INSTRUCTIONS:

- It should be used exclusively in accordance with intended use.
- Mount exclusively in specialized workshops.
- The connection between the lamp and vehicle's installation should be isolated with heat-shrink tube or alternatively with isolating tape to avoid getting water and moisture to the copper wire of the lamp which can damage electronic components. When it comes to lamp and plug, the plug should be mounted safely.
- Do not cut off tinned ends.
- Lamps must be installed only in accordance with UNECE regulations.



www.myKAMAR.com

PHOTO AND TECHNICAL DRAWING:

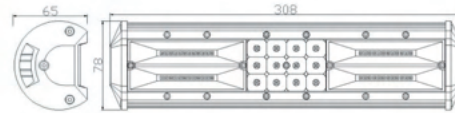

TECHNICAL SPECIFICATIONS:

MATERIAL	LED/LM QUANTITY	MOUNTING	WIRE	FUNCTION	WATT	VOLTAGE	CERTIFICATES	PACKING - BULK BOX
• Housing: AL • Lens: PC	• 60 LED • 3900 LM	• screws	• 300 mm	• work light • combo	• 90W	• 12/24V	• ECE R10	• cart. dim.: 132x115x410mm • weight: 670g • 10 pcs/bulk box

We reserve the right to change technical data and any errors. Photos and specifications are for reference only, and the actual product may vary slightly. Reproduction in whole or parts of the catalog without written authorization is prohibited.



REFERENCE:
LB0077

PANEL LED 72XLED

WARNINGS FOR THE USER:

- Do not look directly into the light - it may cause damage or even loss of vision.
- Install only in specialized workshops or professional services.
- Use in open space only.
- Use in accordance to the purpose.

INSTALLATION INSTRUCTIONS:

- It should be used exclusively in accordance with intended use.
- Mount exclusively in specialized workshops.
- The connection between the lamp and vehicle's installation should be isolated with heat-shrink tube or alternatively with isolating tape to avoid getting water and moisture to the copper wire of the lamp which can damage electronic components. When it comes to lamp and plug, the plug should be mounted safely.
- Do not cut off tinned ends.
- Lamps must be installed only in accordance with UNECE regulations.



www.myKAMAR.com

PHOTO AND TECHNICAL DRAWING:

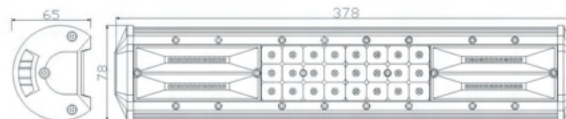
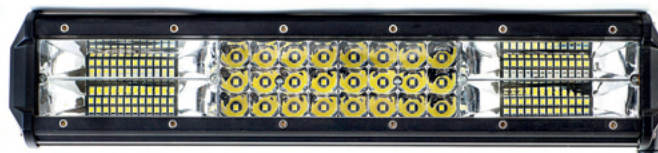

TECHNICAL SPECIFICATIONS:

MATERIAL	LED/LM QUANTITY	MOUNTING	WIRE	FUNCTION	WATT	VOLTAGE	CERTIFICATES	PACKING - BULK BOX
• Housing: AL • Lens: PC	• 78 LED • 13500 LM	• screws	• 300 mm	• work light • combo	• 108W	• 12/24V	• ECE R10	• cart. dim.: 132x115x480mm • weight: 730g • 10 pcs/bulk box

We reserve the right to change technical data and any errors. Photos and specifications are for reference only, and the actual product may vary slightly. Reproduction in whole or parts of the catalog without written authorization is prohibited.



REFERENCE:
LB0078

PANEL LED 84XLED

WARNINGS FOR THE USER:

- Do not look directly into the light - it may cause damage or even loss of vision.
- Install only in specialized workshops or professional services.
- Use in open space only.
- Use in accordance to the purpose.

INSTALLATION INSTRUCTIONS:

- It should be used exclusively in accordance with intended use.
- Mount exclusively in specialized workshops.
- The connection between the lamp and vehicle's installation should be isolated with heat-shrink tube or alternatively with isolating tape to avoid getting water and moisture to the copper wire of the lamp which can damage electronic components. When it comes to lamp and plug, the plug should be mounted safely.
- Do not cut off tinned ends.
- Lamps must be installed only in accordance with UNECE regulations.



www.myKAMAR.com

PHOTO AND TECHNICAL DRAWING:

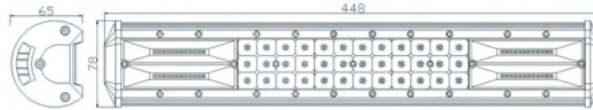

TECHNICAL SPECIFICATIONS:



MATERIAL	LED/LM QUANTITY	MOUNTING	WIRE	FUNCTION	WATT	VOLTAGE	CERTIFICATES	PACKING - BULK BOX
• Housing: AL • Lens: PC	• 84 LED • 5460 LM	• screws	• 300 mm	• work light • combo	• 120W	• 12/24V	• ECE R10	• cart. dim.: 132x115x550mm • weight: 890g • 10 pcs/bulk box

We reserve the right to change technical data and any errors. Photos and specifications are for reference only, and the actual product may vary slightly. Reproduction in whole or parts of the catalog without written authorization is prohibited.



REFERENCE:
LB0080

PANEL LED 108XLED

WARNINGS FOR THE USER:

- Do not look directly into the light - it may cause damage or even loss of vision.
- Install only in specialized workshops or professional services.
- Use in open space only.
- Use in accordance to the purpose.

INSTALLATION INSTRUCTIONS:

- It should be used exclusively in accordance with intended use.
- Mount exclusively in specialized workshops.
- The connection between the lamp and vehicle's installation should be isolated with heat-shrink tube or alternatively with isolating tape to avoid getting water and moisture to the copper wire of the lamp which can damage electronic components. When it comes to lamp and plug, the plug should be mounted safely.
- Do not cut off tinned ends.
- Lamps must be installed only in accordance with UNECE regulations.



www.myKAMAR.com

PHOTO AND TECHNICAL DRAWING:

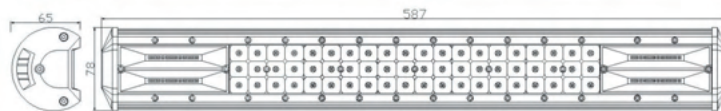
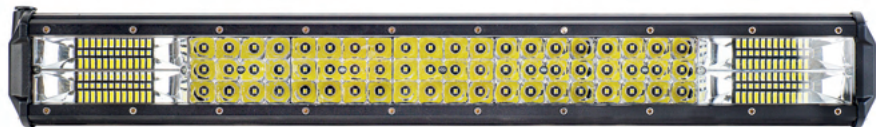

TECHNICAL SPECIFICATIONS:



MATERIAL	LED/LM QUANTITY	MOUNTING	WIRE	FUNCTION	WATT	VOLTAGE	CERTIFICATES	PACKING - BULK BOX
• Housing: AL • Lens: PC	• 108 LED • 7020 LM	• screws	• 300 mm	• work light • combo	• 162W	• 12/24V	• ECE R10	• cart. dim.: 132x116x700mm • weight: 1110g • 8 pcs/bulk box

We reserve the right to change technical data and any errors. Photos and specifications are for reference only, and the actual product may vary slightly. Reproduction in whole or parts of the catalog without written authorization is prohibited.



REFERENCE:
LB0081

PANEL LED 120XLED

WARNINGS FOR THE USER:

- Do not look directly into the light - it may cause damage or even loss of vision.
- Install only in specialized workshops or professional services.
- Use in open space only.
- Use in accordance to the purpose.

INSTALLATION INSTRUCTIONS:

- It should be used exclusively in accordance with intended use.
- Mount exclusively in specialized workshops.
- The connection between the lamp and vehicle's installation should be isolated with heat-shrink tube or alternatively with isolating tape to avoid getting water and moisture to the copper wire of the lamp which can damage electronic components. When it comes to lamp and plug, the plug should be mounted safely.
- Do not cut off tinned ends.
- Lamps must be installed only in accordance with UNECE regulations.



www.myKAMAR.com

PHOTO AND TECHNICAL DRAWING:

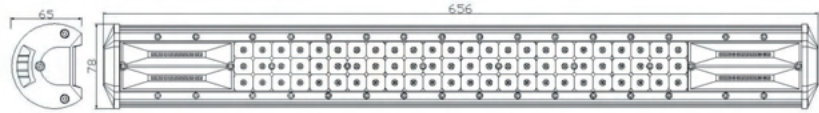

TECHNICAL SPECIFICATIONS:



MATERIAL	LED/LM QUANTITY	MOUNTING	WIRE	FUNCTION	WATT	VOLTAGE	CERTIFICATES	PACKING - BULK BOX
• Housing: AL • Lens: PC	• 120 LED • 7800 LM	• screws	• 300 mm	• work light • combo	• 180W	• 12/24V	• ECE R10	• cart. dim.: 132x115x760mm • weight: 1285g • 8 pcs/bulk box

We reserve the right to change technical data and any errors. Photos and specifications are for reference only, and the actual product may vary slightly. Reproduction in whole or parts of the catalog without written authorization is prohibited.



REFERENCE:
LB0082

PANEL LED 132XLED

WARNINGS FOR THE USER:

- Do not look directly into the light - it may cause damage or even loss of vision.
- Install only in specialized workshops or professional services.
- Use in open space only.
- Use in accordance to the purpose.

INSTALLATION INSTRUCTIONS:

- It should be used exclusively in accordance with intended use.
- Mount exclusively in specialized workshops.
- The connection between the lamp and vehicle's installation should be isolated with heat-shrink tube or alternatively with isolating tape to avoid getting water and moisture to the copper wire of the lamp which can damage electronic components. When it comes to lamp and plug, the plug should be mounted safely.
- Do not cut off tinned ends.
- Lamps must be installed only in accordance with UNECE regulations.



www.myKAMAR.com

PHOTO AND TECHNICAL DRAWING:

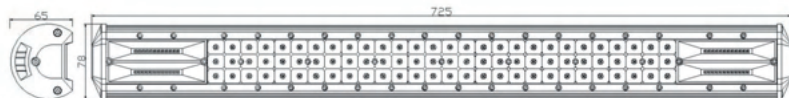

TECHNICAL SPECIFICATIONS:



MATERIAL	LED/LM QUANTITY	MOUNTING	WIRE	FUNCTION	WATT	VOLTAGE	CERTIFICATES	PACKING - BULK BOX
• Housing: AL • Lens: PC	• 132 LED • 8580 LM	• screws	• 300 mm	• work light • combo	• 198W	• 12/24V	• ECE R10	• cart. dim.: 132x116x830mm • weight: 1375g • 8 pcs/bulk box

We reserve the right to change technical data and any errors. Photos and specifications are for reference only, and the actual product may vary slightly. Reproduction in whole or parts of the catalog without written authorization is prohibited.



REFERENCE:
LB0083

PANEL LED 144XLED

WARNINGS FOR THE USER:

- Do not look directly into the light - it may cause damage or even loss of vision.
- Install only in specialized workshops or professional services.
- Use in open space only.
- Use in accordance to the purpose.

INSTALLATION INSTRUCTIONS:

- It should be used exclusively in accordance with intended use.
- Mount exclusively in specialized workshops.
- The connection between the lamp and vehicle's installation should be isolated with heat-shrink tube or alternatively with isolating tape to avoid getting water and moisture to the copper wire of the lamp which can damage electronic components. When it comes to lamp and plug, the plug should be mounted safely.
- Do not cut off tinned ends.
- Lamps must be installed only in accordance with UNECE regulations.



www.myKAMAR.com

PHOTO AND TECHNICAL DRAWING:

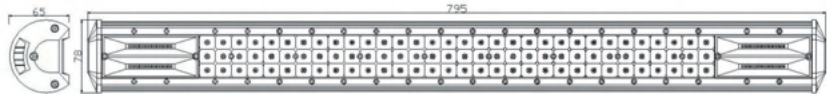

TECHNICAL SPECIFICATIONS:



MATERIAL	LED/LM QUANTITY	MOUNTING	WIRE	FUNCTION	WATT	VOLTAGE	CERTIFICATES	PACKING - BULK BOX
• Housing: AL • Lens: PC	• 144 LED • 9360 LM	• screws	• 300 mm	• work light • combo	• 210W	• 12/24V	• ECE R10	• cart. dim.: 132x115x900mm • weight: 1485g • 6 pcs/bulk box

We reserve the right to change technical data and any errors. Photos and specifications are for reference only, and the actual product may vary slightly. Reproduction in whole or parts of the catalog without written authorization is prohibited.



REFERENCE:
LB0084

PANEL LED 156XLED

WARNINGS FOR THE USER:

- Do not look directly into the light - it may cause damage or even loss of vision.
- Install only in specialized workshops or professional services.
- Use in open space only.
- Use in accordance to the purpose.

INSTALLATION INSTRUCTIONS:

- It should be used exclusively in accordance with intended use.
- Mount exclusively in specialized workshops.
- The connection between the lamp and vehicle's installation should be isolated with heat-shrink tube or alternatively with isolating tape to avoid getting water and moisture to the copper wire of the lamp which can damage electronic components. When it comes to lamp and plug, the plug should be mounted safely.
- Do not cut off tinned ends.
- Lamps must be installed only in accordance with UNECE regulations.



www.myKAMAR.com

PHOTO AND TECHNICAL DRAWING:

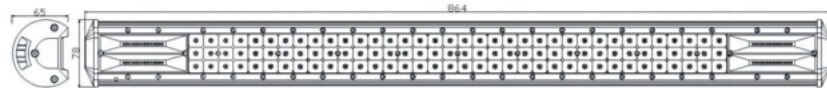

TECHNICAL SPECIFICATIONS:



MATERIAL	LED/LM QUANTITY	MOUNTING	WIRE	FUNCTION	WATT	VOLTAGE	CERTIFICATES	PACKING - BULK BOX
• Housing: AL • Lens: PC	• 156 LED • 10140 LM	• screws	• 300 mm	• work light • combo	• 234W	• 12/24V	• ECE R10	• cart. dim.: 132x115x1000mm • weight: 1595g • 6 pcs/bulk box

We reserve the right to change technical data and any errors. Photos and specifications are for reference only, and the actual product may vary slightly. Reproduction in whole or parts of the catalog without written authorization is prohibited.



REFERENCE:
LB0085

PANEL LED 168XLED

WARNINGS FOR THE USER:

- Do not look directly into the light - it may cause damage or even loss of vision.
- Install only in specialized workshops or professional services.
- Use in open space only.
- Use in accordance to the purpose.

INSTALLATION INSTRUCTIONS:

- It should be used exclusively in accordance with intended use.
- Mount exclusively in specialized workshops.
- The connection between the lamp and vehicle's installation should be isolated with heat-shrink tube or alternatively with isolating tape to avoid getting water and moisture to the copper wire of the lamp which can damage electronic components. When it comes to lamp and plug, the plug should be mounted safely.
- Do not cut off tinned ends.
- Lamps must be installed only in accordance with UNECE regulations.



www.myKAMAR.com

PHOTO AND TECHNICAL DRAWING:

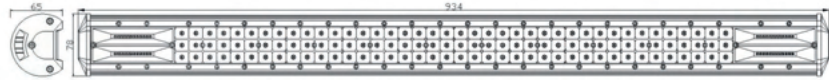

TECHNICAL SPECIFICATIONS:



MATERIAL	LED/LM QUANTITY	MOUNTING	WIRE	FUNCTION	WATT	VOLTAGE	CERTIFICATES	PACKING - BULK BOX
• Housing: AL • Lens: PC	• 168 LED • 10920 LM	• screws	• 300 mm	• work light • combo	• 252W	• 12/24V	• ECE R10	• cart. dim.: 132x115x1050mm • weight: 1750g • 6 pcs/bulk box

We reserve the right to change technical data and any errors. Photos and specifications are for reference only, and the actual product may vary slightly. Reproduction in whole or parts of the catalog without written authorization is prohibited.



REFERENCE:
LB0086

PANEL LED 20XLED

WARNINGS FOR THE USER:

- Do not look directly into the light - it may cause damage or even loss of vision.
- Install only in specialized workshops or professional services.
- Use in open space only.
- Use in accordance to the purpose.

INSTALLATION INSTRUCTIONS:

- It should be used exclusively in accordance with intended use.
- Mount exclusively in specialized workshops.
- The connection between the lamp and vehicle's installation should be isolated with heat-shrink tube or alternatively with isolating tape to avoid getting water and moisture to the copper wire of the lamp which can damage electronic components. When it comes to lamp and plug, the plug should be mounted safely.
- Do not cut off tinned ends.
- Lamps must be installed only in accordance with UNECE regulations.



www.myKAMAR.com

PHOTO AND TECHNICAL DRAWING:

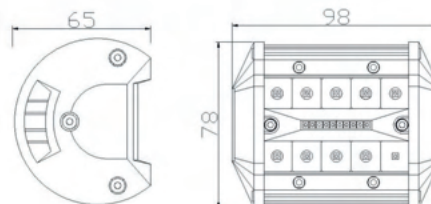

TECHNICAL SPECIFICATIONS:



MATERIAL	LED/LM QUANTITY	MOUNTING	WIRE	FUNCTION	WATT	VOLTAGE	CERTIFICATES	PACKING - BULK BOX
• Housing: AL • Lens: PC	• 20 LED • 1300 LM	• screws	• 300 mm	• work light • combo	• 30W	• 12/24V	• ECE R10	• cart. dim.: 100x90x90mm • weight: 3150g • 40 pcs/bulk box

We reserve the right to change technical data and any errors. Photos and specifications are for reference only, and the actual product may vary slightly. Reproduction in whole or parts of the catalog without written authorization is prohibited.



REFERENCE:
LB0085

PANEL LED 168XLLED

WARNINGS FOR THE USER:

- Do not look directly into the light - it may cause damage or even loss of vision.
- Install only in specialized workshops or professional services.
- Use in open space only.
- Use in accordance to the purpose.

INSTALLATION INSTRUCTIONS:

- It should be used exclusively in accordance with intended use.
- Mount exclusively in specialized workshops.
- The connection between the lamp and vehicle's installation should be isolated with heat-shrink tube or alternatively with isolating tape to avoid getting water and moisture to the copper wire of the lamp which can damage electronic components. When it comes to lamp and plug, the plug should be mounted safely.
- Do not cut off tinned ends.
- Lamps must be installed only in accordance with UNECE regulations.



www.myKAMAR.com

PHOTO AND TECHNICAL DRAWING:

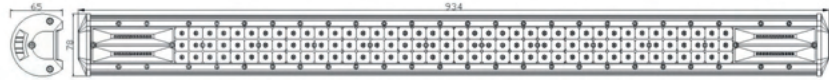

TECHNICAL SPECIFICATIONS:

MATERIAL	LED/LM QUANTITY	MOUNTING	WIRE	FUNCTION	WATT	VOLTAGE	CERTIFICATES	PACKING - BULK BOX
• Housing: AL • Lens: PC	• 168 LED • 10920 LM	• screws	• 300 mm	• work light • combo	• 252W	• 12/24V	• ECE R10	• cart. dim.: 132x115x1050mm • weight: 1750g • 6 pcs/bulk box

We reserve the right to change technical data and any errors. Photos and specifications are for reference only, and the actual product may vary slightly. Reproduction in whole or parts of the catalog without written authorization is prohibited.



REFERENCE:
LB0086

PANEL LED 20XLLED

WARNINGS FOR THE USER:

- Do not look directly into the light - it may cause damage or even loss of vision.
- Install only in specialized workshops or professional services.
- Use in open space only.
- Use in accordance to the purpose.

INSTALLATION INSTRUCTIONS:

- It should be used exclusively in accordance with intended use.
- Mount exclusively in specialized workshops.
- The connection between the lamp and vehicle's installation should be isolated with heat-shrink tube or alternatively with isolating tape to avoid getting water and moisture to the copper wire of the lamp which can damage electronic components. When it comes to lamp and plug, the plug should be mounted safely.
- Do not cut off tinned ends.
- Lamps must be installed only in accordance with UNECE regulations.

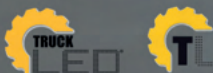

www.myKAMAR.com

PHOTO AND TECHNICAL DRAWING:

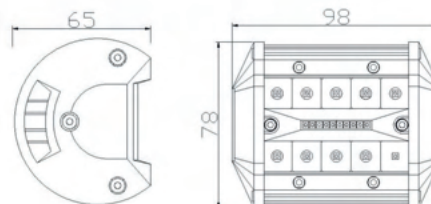

TECHNICAL SPECIFICATIONS:

MATERIAL	LED/LM QUANTITY	MOUNTING	WIRE	FUNCTION	WATT	VOLTAGE	CERTIFICATES	PACKING - BULK BOX
• Housing: AL • Lens: PC	• 20 LED • 1300 LM	• screws	• 300 mm	• work light • combo	• 30W	• 12/24V	• ECE R10	• cart. dim.: 100x90x90mm • weight: 3150g • 40 pcs/bulk box

We reserve the right to change technical data and any errors. Photos and specifications are for reference only, and the actual product may vary slightly. Reproduction in whole or parts of the catalog without written authorization is prohibited.



REFERENCE:
LB0087

PANEL LED 40XLED

WARNINGS FOR THE USER:

- Do not look directly into the light - it may cause damage or even loss of vision.
- Install only in specialized workshops or professional services.
- Use in open space only.
- Use in accordance to the purpose.

INSTALLATION INSTRUCTIONS:

- It should be used exclusively in accordance with intended use.
- Mount exclusively in specialized workshops.
- The connection between the lamp and vehicle's installation should be isolated with heat-shrink tube or alternatively with isolating tape to avoid getting water and moisture to the copper wire of the lamp which can damage electronic components. When it comes to lamp and plug, the plug should be mounted safely.
- Do not cut off tinned ends.
- Lamps must be installed only in accordance with UNECE regulations.



www.myKAMAR.com

PHOTO AND TECHNICAL DRAWING:

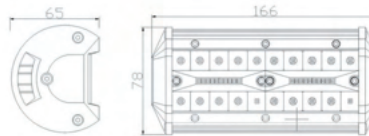
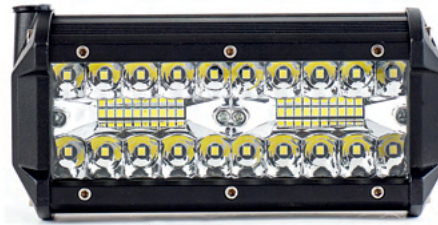

TECHNICAL SPECIFICATIONS:

MATERIAL	LED/LM QUANTITY	MOUNTING	WIRE	FUNCTION	WATT	VOLTAGE	CERTIFICATES	PACKING - BULK BOX
• Housing: AL • Lens: PC	• 40 LED • 2600 LM	• screws	• 300 mm	• work light • combo	• 60W	• 12/24V	• ECE R10	• cart. dim.: 132x115x260mm • weight: 425g • 20 pcs/bulk box

We reserve the right to change technical data and any errors. Photos and specifications are for reference only, and the actual product may vary slightly. Reproduction in whole or parts of the catalog without written authorization is prohibited.



REFERENCE:
LB0088

PANEL LED 60XLED

WARNINGS FOR THE USER:

- Do not look directly into the light - it may cause damage or even loss of vision.
- Install only in specialized workshops or professional services.
- Use in open space only.
- Use in accordance to the purpose.

INSTALLATION INSTRUCTIONS:

- It should be used exclusively in accordance with intended use.
- Mount exclusively in specialized workshops.
- The connection between the lamp and vehicle's installation should be isolated with heat-shrink tube or alternatively with isolating tape to avoid getting water and moisture to the copper wire of the lamp which can damage electronic components. When it comes to lamp and plug, the plug should be mounted safely.
- Do not cut off tinned ends.
- Lamps must be installed only in accordance with UNECE regulations.



www.myKAMAR.com

PHOTO AND TECHNICAL DRAWING:

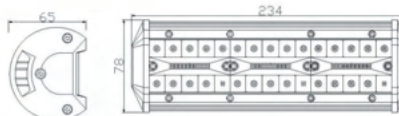
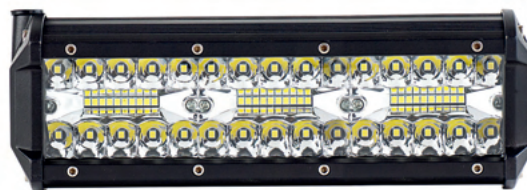

TECHNICAL SPECIFICATIONS:

MATERIAL	LED/LM QUANTITY	MOUNTING	WIRE	FUNCTION	WATT	VOLTAGE	CERTIFICATES	PACKING - BULK BOX
• Housing: AL • Lens: PC	• 60 LED • 3900 LM	• screws	• 300 mm	• work light • combo	• 90W	• 12/24V	• ECE R10	• cart. dim.: 132x115x340mm • weight: 535g • 20 pcs/bulk box

We reserve the right to change technical data and any errors. Photos and specifications are for reference only, and the actual product may vary slightly. Reproduction in whole or parts of the catalog without written authorization is prohibited.



REFERENCE:
LB0089

PANEL LED 80XLED

WARNINGS FOR THE USER:

- Do not look directly into the light - it may cause damage or even loss of vision.
- Install only in specialized workshops or professional services.
- Use in open space only.
- Use in accordance to the purpose.

INSTALLATION INSTRUCTIONS:

- It should be used exclusively in accordance with intended use.
- Mount exclusively in specialized workshops.
- The connection between the lamp and vehicle's installation should be isolated with heat-shrink tube or alternatively with isolating tape to avoid getting water and moisture to the copper wire of the lamp which can damage electronic components. When it comes to lamp and plug, the plug should be mounted safely.
- Do not cut off tinned ends.
- Lamps must be installed only in accordance with UNECE regulations.



www.myKAMAR.com

PHOTO AND TECHNICAL DRAWING:

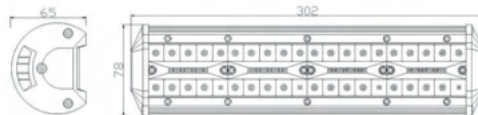
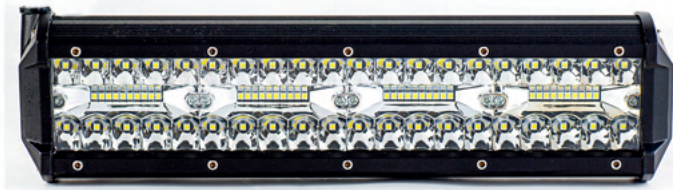

TECHNICAL SPECIFICATIONS:

MATERIAL	LED/LM QUANTITY	MOUNTING	WIRE	FUNCTION	WATT	VOLTAGE	CERTIFICATES	PACKING - BULK BOX
• Housing: AL • Lens: PC	• 80 LED • 5200 LM	• screws	• 300 mm	• work light • combo	• 120W	• 12/24V	• ECE R10	• cart. dim.: 132x115x410mm • weight: 690g • 10 pcs/bulk box

We reserve the right to change technical data and any errors. Photos and specifications are for reference only, and the actual product may vary slightly. Reproduction in whole or parts of the catalog without written authorization is prohibited.



REFERENCE:
LB0090

PANEL LED 100XLED

WARNINGS FOR THE USER:

- Do not look directly into the light - it may cause damage or even loss of vision.
- Install only in specialized workshops or professional services.
- Use in open space only.
- Use in accordance to the purpose.

INSTALLATION INSTRUCTIONS:

- It should be used exclusively in accordance with intended use.
- Mount exclusively in specialized workshops.
- The connection between the lamp and vehicle's installation should be isolated with heat-shrink tube or alternatively with isolating tape to avoid getting water and moisture to the copper wire of the lamp which can damage electronic components. When it comes to lamp and plug, the plug should be mounted safely.
- Do not cut off tinned ends.
- Lamps must be installed only in accordance with UNECE regulations.



www.myKAMAR.com

PHOTO AND TECHNICAL DRAWING:

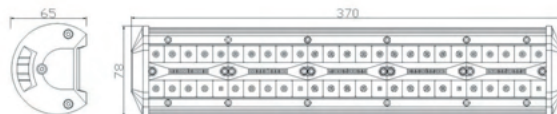
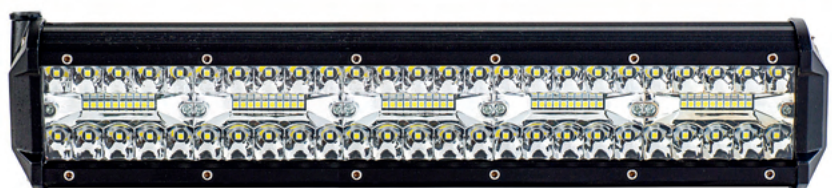

TECHNICAL SPECIFICATIONS:

MATERIAL	LED/LM QUANTITY	MOUNTING	WIRE	FUNCTION	WATT	VOLTAGE	CERTIFICATES	PACKING - BULK BOX
• Housing: AL • Lens: PC	• 100 LED • 6500 LM	• screws	• 300 mm	• work light • combo	• 150W	• 12/24V	• ECE R10	• cart. dim.: 132x115x480mm • weight: 800g • 10 pcs/bulk box

We reserve the right to change technical data and any errors. Photos and specifications are for reference only, and the actual product may vary slightly. Reproduction in whole or parts of the catalog without written authorization is prohibited.



REFERENCE:
LB0091

PANEL LED 120XL2D

WARNINGS FOR THE USER:

- Do not look directly into the light - it may cause damage or even loss of vision.
- Install only in specialized workshops or professional services.
- Use in open space only.
- Use in accordance to the purpose.

INSTALLATION INSTRUCTIONS:

- It should be used exclusively in accordance with intended use.
- Mount exclusively in specialized workshops.
- The connection between the lamp and vehicle's installation should be isolated with heat-shrink tube or alternatively with isolating tape to avoid getting water and moisture to the copper wire of the lamp which can damage electronic components. When it comes to lamp and plug, the plug should be mounted safely.
- Do not cut off tinned ends.
- Lamps must be installed only in accordance with UNECE regulations.



www.myKAMAR.com

PHOTO AND TECHNICAL DRAWING:

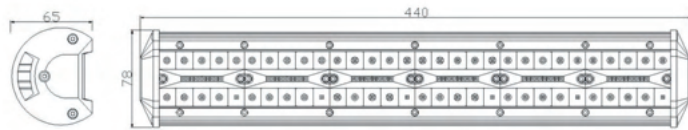
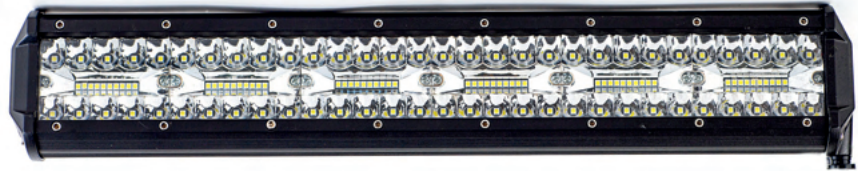

TECHNICAL SPECIFICATIONS:



MATERIAL	LED/LM QUANTITY	MOUNTING	WIRE	FUNCTION	WATT	VOLTAGE	CERTIFICATES	PACKING - BULK BOX
• Housing: AL • Lens: PC	• 120 LED • 7800 LM	• screws	• 300 mm	• work light • combo	• 180W	• 12/24V	• ECE R10	• cart. dim.: 132x115x550mm • weight: 910g • 10 pcs/bulk box

We reserve the right to change technical data and any errors. Photos and specifications are for reference only, and the actual product may vary slightly. Reproduction in whole or parts of the catalog without written authorization is prohibited.



REFERENCE:
LB0092

PANEL LED 140XL2D

WARNINGS FOR THE USER:

- Do not look directly into the light - it may cause damage or even loss of vision.
- Install only in specialized workshops or professional services.
- Use in open space only.
- Use in accordance to the purpose.

INSTALLATION INSTRUCTIONS:

- It should be used exclusively in accordance with intended use.
- Mount exclusively in specialized workshops.
- The connection between the lamp and vehicle's installation should be isolated with heat-shrink tube or alternatively with isolating tape to avoid getting water and moisture to the copper wire of the lamp which can damage electronic components. When it comes to lamp and plug, the plug should be mounted safely.
- Do not cut off tinned ends.
- Lamps must be installed only in accordance with UNECE regulations.

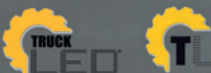

www.myKAMAR.com

PHOTO AND TECHNICAL DRAWING:

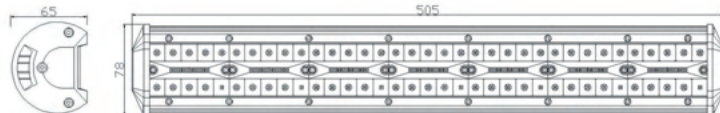

TECHNICAL SPECIFICATIONS:



MATERIAL	LED/LM QUANTITY	MOUNTING	WIRE	FUNCTION	WATT	VOLTAGE	CERTIFICATES	PACKING - BULK BOX
• Housing: AL • Lens: PC	• 140 LED • 9100 LM	• screws	• 300 mm	• work light • combo	• 210W	• 12/24V	• ECE R10	• cart. dim.: 132x115x610mm • weight: 1020g • 10 pcs/bulk box

We reserve the right to change technical data and any errors. Photos and specifications are for reference only, and the actual product may vary slightly. Reproduction in whole or parts of the catalog without written authorization is prohibited.



REFERENCE:
LB0093

PANEL LED 160XLED

WARNINGS FOR THE USER:

- Do not look directly into the light - it may cause damage or even loss of vision.
- Install only in specialized workshops or professional services.
- Use in open space only.
- Use in accordance to the purpose.

INSTALLATION INSTRUCTIONS:

- It should be used exclusively in accordance with intended use.
- Mount exclusively in specialized workshops.
- The connection between the lamp and vehicle's installation should be isolated with heat-shrink tube or alternatively with isolating tape to avoid getting water and moisture to the copper wire of the lamp which can damage electronic components. When it comes to lamp and plug, the plug should be mounted safely.
- Do not cut off tinned ends.
- Lamps must be installed only in accordance with UNECE regulations.



www.myKAMAR.com

PHOTO AND TECHNICAL DRAWING:

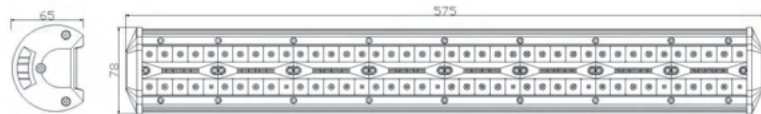
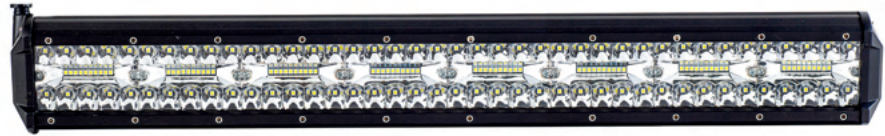

TECHNICAL SPECIFICATIONS:



MATERIAL	LED/LM QUANTITY	MOUNTING	WIRE	FUNCTION	WATT	VOLTAGE	CERTIFICATES	PACKING - BULK BOX
• Housing: AL • Lens: PC	• 160 LED • 10400 LM	• screws	• 300 mm	• work light • combo	• 240W	• 12/24V	• ECE R10	• cart. dim.: 132x115x700mm • weight:1130g • 6 pcs/bulk box

We reserve the right to change technical data and any errors. Photos and specifications are for reference only, and the actual product may vary slightly. Reproduction in whole or parts of the catalog without written authorization is prohibited.



REFERENCE:
LB0094

PANEL LED 180XLED

WARNINGS FOR THE USER:

- Do not look directly into the light - it may cause damage or even loss of vision.
- Install only in specialized workshops or professional services.
- Use in open space only.
- Use in accordance to the purpose.

INSTALLATION INSTRUCTIONS:

- It should be used exclusively in accordance with intended use.
- Mount exclusively in specialized workshops.
- The connection between the lamp and vehicle's installation should be isolated with heat-shrink tube or alternatively with isolating tape to avoid getting water and moisture to the copper wire of the lamp which can damage electronic components. When it comes to lamp and plug, the plug should be mounted safely.
- Do not cut off tinned ends.
- Lamps must be installed only in accordance with UNECE regulations.



www.myKAMAR.com

PHOTO AND TECHNICAL DRAWING:

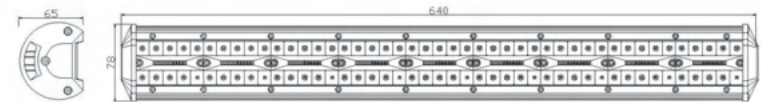
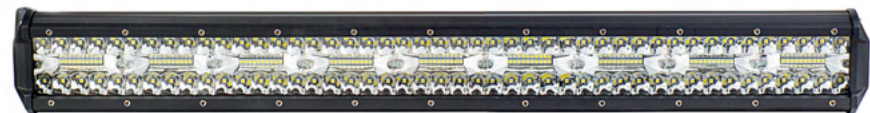

TECHNICAL SPECIFICATIONS:



MATERIAL	LED/LM QUANTITY	MOUNTING	WIRE	FUNCTION	WATT	VOLTAGE	CERTIFICATES	PACKING - BULK BOX
• Housing: AL • Lens: PC	• 180 LED • 11700 LM	• screws	• 300 mm	• work light • combo	• 153W	• 12/24V	• ECE R10	• cart. dim.: 132x115x780mm • weight:1285g • 6 pcs/bulk box

We reserve the right to change technical data and any errors. Photos and specifications are for reference only, and the actual product may vary slightly. Reproduction in whole or parts of the catalog without written authorization is prohibited.



REFERENCE:
LB0095

PANEL LED 200XLED

WARNINGS FOR THE USER:

- Do not look directly into the light - it may cause damage or even loss of vision.
- Install only in specialized workshops or professional services.
- Use in open space only.
- Use in accordance to the purpose.

INSTALLATION INSTRUCTIONS:

- It should be used exclusively in accordance with intended use.
- Mount exclusively in specialized workshops.
- The connection between the lamp and vehicle's installation should be isolated with heat-shrink tube or alternatively with isolating tape to avoid getting water and moisture to the copper wire of the lamp which can damage electronic components. When it comes to lamp and plug, the plug should be mounted safely.
- Do not cut off tinned ends.
- Lamps must be installed only in accordance with UNECE regulations.



www.myKAMAR.com

PHOTO AND TECHNICAL DRAWING:

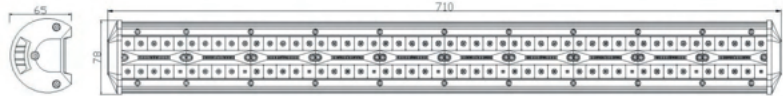

TECHNICAL SPECIFICATIONS:

MATERIAL	LED/LM QUANTITY	MOUNTING	WIRE	FUNCTION	WATT	VOLTAGE	CERTIFICATES	PACKING - BULK BOX
• Housing: AL • Lens: PC	• 200 LED • 13000 LM	• screws	• 300 mm	• work light • combo	• 164W	• 12/24V	• ECE R10	• cart. dim.: 132x115x830mm • weight:1395g • 6 pcs/bulk box

We reserve the right to change technical data and any errors. Photos and specifications are for reference only, and the actual product may vary slightly. Reproduction in whole or parts of the catalog without written authorization is prohibited.



REFERENCE:
LB0096

PANEL LED 16+57 LED STIPE+ DT CONNECTOR

WARNINGS FOR THE USER:

- Do not look directly into the light - it may cause damage or even loss of vision.
- Install only in specialized workshops or professional services.
- Use in open space only.
- Use in accordance to the purpose.

INSTALLATION INSTRUCTIONS:

- It should be used exclusively in accordance with intended use.
- Mount exclusively in specialized workshops.
- The connection between the lamp and vehicle's installation should be isolated with heat-shrink tube or alternatively with isolating tape to avoid getting water and moisture to the copper wire of the lamp which can damage electronic components. When it comes to lamp and plug, the plug should be mounted safely.
- Do not cut off tinned ends.
- Lamps must be installed only in accordance with UNECE regulations.



www.myKAMAR.com

PHOTO AND TECHNICAL DRAWING:

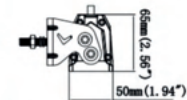
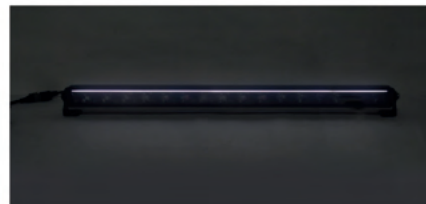
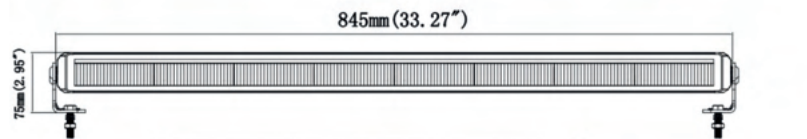

TECHNICAL SPECIFICATIONS:

MATERIAL	LED/LM QUANTITY	MOUNTING	WIRE	FUNCTION	WATT	VOLTAGE	CERTIFICATES	PACKING - BULK BOX
• Housing: AL • Lens: PC	• 16-57 LED • 10279 LM • 16 LM	• screws	• 250 mm with DT connector	• work light • combo • LED strip	• 124W-10W	• 12/24V	• ECE R10	• cart. dim.: 960x110x680mm • weight:3000g • 4 pcs/bulk box

We reserve the right to change technical data and any errors. Photos and specifications are for reference only, and the actual product may vary slightly. Reproduction in whole or parts of the catalog without written authorization is prohibited.



**REFERENCE:
LB0097**

**PANEL LED 20XLED + 72XLED
STIPE+ DT CONNECTOR**

WARNINGS FOR THE USER:

- Do not look directly into the light - it may cause damage or even loss of vision.
- Install only in specialized workshops or professional services.
- Use in open space only.
- Use in accordance to the purpose.

INSTALLATION INSTRUCTIONS:

- It should be used exclusively in accordance with intended use.
- Mount exclusively in specialized workshops.
- The connection between the lamp and vehicle's installation should be isolated with heat-shrink tube or alternatively with isolating tape to avoid getting water and moisture to the copper wire of the lamp which can damage electronic components. When it comes to lamp and plug, the plug should be mounted safely.
- Do not cut off tinned ends.
- Lamps must be installed only in accordance with UNECE regulations.



www.myKAMAR.com

PHOTO AND TECHNICAL DRAWING:

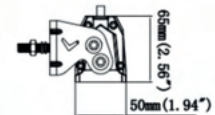
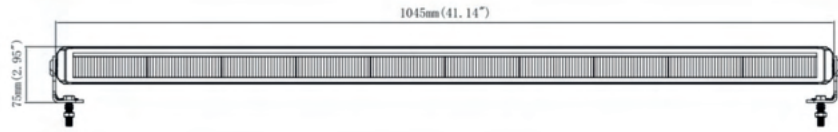

TECHNICAL SPECIFICATIONS:

MATERIAL	LED/LM QUANTITY	MOUNTING	WIRE	FUNCTION	WATT	VOLTAGE	CERTIFICATES	PACKING - BULK BOX
• Housing: AL • Lens: PC	• 20•72 LED • 12690 LM • 16 LM	• screws	• 250 mm with DT connector	• work light • combo • LED strip	• 178W•10W	• 12/24V	• ECE R10	• cart. dim.: 1160x110x68mm • weight:3900g • 4 pcs/bulk box

We reserve the right to change technical data and any errors. Photos and specifications are for reference only, and the actual product may vary slightly. Reproduction in whole or parts of the catalog without written authorization is prohibited.



**REFERENCE:
LB0098**

**PANEL LED BEZEL-LESS 36+72
LED STRIPE+ DT CONNECTOR**

WARNINGS FOR THE USER:

- Do not look directly into the light - it may cause damage or even loss of vision.
- Install only in specialized workshops or professional services.
- Use in open space only.
- Use in accordance to the purpose.

INSTALLATION INSTRUCTIONS:

- It should be used exclusively in accordance with intended use.
- Mount exclusively in specialized workshops.
- The connection between the lamp and vehicle's installation should be isolated with heat-shrink tube or alternatively with isolating tape to avoid getting water and moisture to the copper wire of the lamp which can damage electronic components. When it comes to lamp and plug, the plug should be mounted safely.
- Do not cut off tinned ends.
- Lamps must be installed only in accordance with UNECE regulations.



www.myKAMAR.com

PHOTO AND TECHNICAL DRAWING:

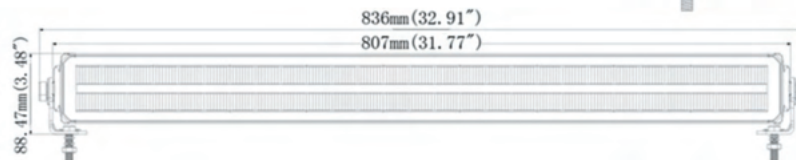
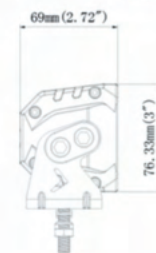
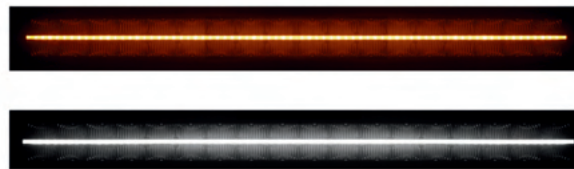

TECHNICAL SPECIFICATIONS:

MATERIAL	LED/LM QUANTITY	MOUNTING	WIRE	FUNCTION	WATT	VOLTAGE	CERTIFICATES	PACKING - BULK BOX
• Housing: AL • Lens: PC	• 36•72 LED • 612 LM • 12212 LM	• screws 2 types	• 250 mm with DT connector	• work light • combo • LED strip White + Amber	• 13W•140W	• 12/24V	• ECE R10	• cart. dim.: 920x111x93mm • weight:4000g • 4 pcs/bulk box

We reserve the right to change technical data and any errors. Photos and specifications are for reference only, and the actual product may vary slightly. Reproduction in whole or parts of the catalog without written authorization is prohibited.



REFERENCE:
LB0099

**PANEL LED BEZEL-LESS 48+96
LED STIPE+ DT CONNECTOR**

WARNINGS FOR THE USER:

- Do not look directly into the light - it may cause damage or even loss of vision.
- Install only in specialized workshops or professional services.
- Use in open space only.
- Use in accordance to the purpose.

INSTALLATION INSTRUCTIONS:

- It should be used exclusively in accordance with intended use.
- Mount exclusively in specialized workshops.
- The connection between the lamp and vehicle's installation should be isolated with heat-shrink tube or alternatively with isolating tape to avoid getting water and moisture to the copper wire of the lamp which can damage electronic components. When it comes to lamp and plug, the plug should be mounted safely.
- Do not cut off tinned ends.
- Lamps must be installed only in accordance with UNECE regulations.



www.myKAMAR.com

PHOTO AND TECHNICAL DRAWING:

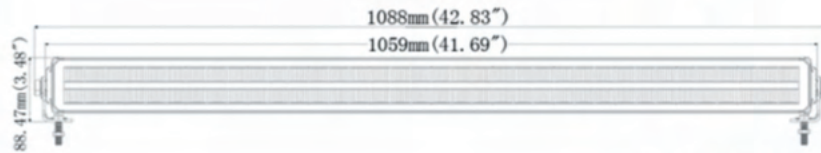
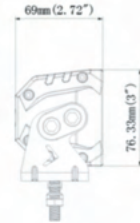
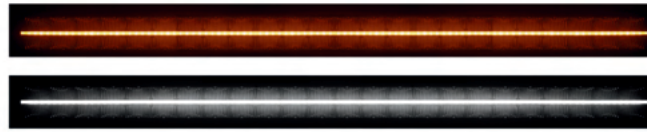

TECHNICAL SPECIFICATIONS:

MATERIAL	LED/LM QUANTITY	MOUNTING	WIRE	FUNCTION	WATT	VOLTAGE	CERTIFICATES	PACKING - BULK BOX
• Housing: AL • Lens: PC	• 48+96 LED • 700 LM • 15000 LM	• screws 2 types	• 250 mm with DT connector	• work light • combo • LED strip White • Amber	• 15W+180W	• 12/24V	• ECE R10	• cart. dim.: 1110x111x93mm • weight:5260g • 4 pcs/bulk box

We reserve the right to change technical data and any errors. Photos and specifications are for reference only, and the actual product may vary slightly. Reproduction in whole or parts of the catalog without written authorization is prohibited.



REFERENCE:
LB0100

PANEL LED 6XLED

WARNINGS FOR THE USER:

- Do not look directly into the light - it may cause damage or even loss of vision.
- Install only in specialized workshops or professional services.
- Use in open space only.
- Use in accordance to the purpose.

INSTALLATION INSTRUCTIONS:

- It should be used exclusively in accordance with intended use.
- Mount exclusively in specialized workshops.
- The connection between the lamp and vehicle's installation should be isolated with heat-shrink tube or alternatively with isolating tape to avoid getting water and moisture to the copper wire of the lamp which can damage electronic components. When it comes to lamp and plug, the plug should be mounted safely.
- Do not cut off tinned ends.
- Lamps must be installed only in accordance with UNECE regulations.

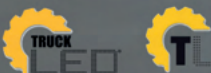

www.myKAMAR.com

PHOTO AND TECHNICAL DRAWING:

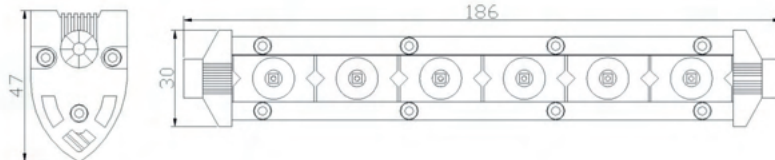

TECHNICAL SPECIFICATIONS:

MATERIAL	LED/LM QUANTITY	MOUNTING	WIRE	FUNCTION	WATT	VOLTAGE	CERTIFICATES	PACKING/WEIGHT
• Lens: PC • Housing: AL	• 6 LED • 720 LM	• screws	• 0.3m	• work light • flood	• 9,6W	• 12/24V	• ECE R10	• cart. dim.: 48x22x30cm • weight: 13kg • 60 pcs/bulk box

We reserve the right to change technical data and any errors. Photos and specifications are for reference only, and the actual product may vary slightly. Reproduction in whole or parts of the catalog without written authorization is prohibited.



**REFERENCE:
LB0101**

PANEL LED 9XLED

WARNINGS FOR THE USER:

- Do not look directly into the light - it may cause damage or even loss of vision.
- Install only in specialized workshops or professional services.
- Use in open space only.
- Use in accordance to the purpose.

INSTALLATION INSTRUCTIONS:

- It should be used exclusively in accordance with intended use.
- Mount exclusively in specialized workshops.
- The connection between the lamp and vehicle's installation should be isolated with heat-shrink tube or alternatively with isolating tape to avoid getting water and moisture to the copper wire of the lamp which can damage electronic components. When it comes to lamp and plug, the plug should be mounted safely.
- Do not cut off tinned ends.
- Lamps must be installed only in accordance with UNECE regulations.



www.myKAMAR.com

PHOTO AND TECHNICAL DRAWING:

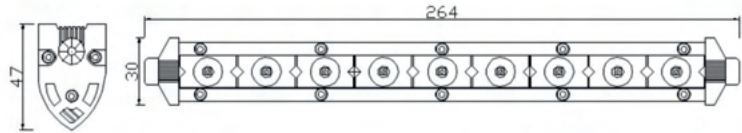

TECHNICAL SPECIFICATIONS:

MATERIAL	LED/LM QUANTITY	MOUNTING	WIRE	FUNCTION	WATT	VOLTAGE	CERTIFICATES	PACKING/WEIGHT
• Lens: PC • Housing: AL	• 9 LED • 900 LM	• screws	• 0.3 m	• work light • flood	• 16,6W	• 12/24V	• ECE R10	• cart. dim.: 49x31,5x30cm • weight: 17kg • 50 pcs/bulk box

We reserve the right to change technical data and any errors. Photos and specifications are for reference only, and the actual product may vary slightly. Reproduction in whole or parts of the catalog without written authorization is prohibited.



**REFERENCE:
LB0102**

PANEL LED 12XLED

WARNINGS FOR THE USER:

- Do not look directly into the light - it may cause damage or even loss of vision.
- Install only in specialized workshops or professional services.
- Use in open space only.
- Use in accordance to the purpose.

INSTALLATION INSTRUCTIONS:

- It should be used exclusively in accordance with intended use.
- Mount exclusively in specialized workshops.
- The connection between the lamp and vehicle's installation should be isolated with heat-shrink tube or alternatively with isolating tape to avoid getting water and moisture to the copper wire of the lamp which can damage electronic components. When it comes to lamp and plug, the plug should be mounted safely.
- Do not cut off tinned ends.
- Lamps must be installed only in accordance with UNECE regulations.



www.myKAMAR.com

PHOTO AND TECHNICAL DRAWING:

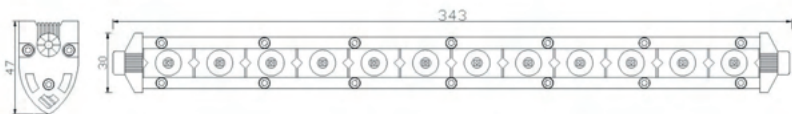

TECHNICAL SPECIFICATIONS:

MATERIAL	LED/LM QUANTITY	MOUNTING	WIRE	FUNCTION	WATT	VOLTAGE	CERTIFICATES	PACKING/WEIGHT
• Lens: PC • Housing: AL	• 12 LED • 1200LM	• screws	• 0.3 m	• work light • flood	• 17W	• 12/24V	• ECE R10	• cart. dim.: 59x40x25cm • weight: 21kg • 50 pcs/bulk box

We reserve the right to change technical data and any errors. Photos and specifications are for reference only, and the actual product may vary slightly. Reproduction in whole or parts of the catalog without written authorization is prohibited.



REFERENCE:
LB0103

PANEL LED 18XLED

WARNINGS FOR THE USER:

- Do not look directly into the light - it may cause damage or even loss of vision.
- Install only in specialized workshops or professional services.
- Use in open space only.
- Use in accordance to the purpose.

INSTALLATION INSTRUCTIONS:

- It should be used exclusively in accordance with intended use.
- Mount exclusively in specialized workshops.
- The connection between the lamp and vehicle's installation should be isolated with heat-shrink tube or alternatively with isolating tape to avoid getting water and moisture to the copper wire of the lamp which can damage electronic components. When it comes to lamp and plug, the plug should be mounted safely.
- Do not cut off tinned ends.
- Lamps must be installed only in accordance with UNECE regulations.



www.myKAMAR.com

PHOTO AND TECHNICAL DRAWING:

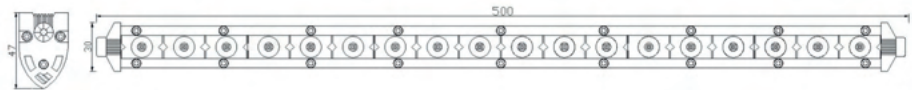

TECHNICAL SPECIFICATIONS:

MATERIAL	LED/LM QUANTITY	MOUNTING	WIRE	FUNCTION	WATT	VOLTAGE	CERTIFICATES	PACKING/WEIGHT
• Lens: PC • Housing: AL	• 18 LED • 2000LM	• screws	• 0.3 m	• work light • flood	• 32W	• 12/24V	• ECE R10	• cart. dim.: 55x41x31,5cm • weight: 22kg • 60 pcs/bulk box

We reserve the right to change technical data and any errors. Photos and specifications are for reference only, and the actual product may vary slightly. Reproduction in whole or parts of the catalog without written authorization is prohibited.



REFERENCE:
LB0104

PANEL LED 24XLED

WARNINGS FOR THE USER:

- Do not look directly into the light - it may cause damage or even loss of vision.
- Install only in specialized workshops or professional services.
- Use in open space only.
- Use in accordance to the purpose.

INSTALLATION INSTRUCTIONS:

- It should be used exclusively in accordance with intended use.
- Mount exclusively in specialized workshops.
- The connection between the lamp and vehicle's installation should be isolated with heat-shrink tube or alternatively with isolating tape to avoid getting water and moisture to the copper wire of the lamp which can damage electronic components. When it comes to lamp and plug, the plug should be mounted safely.
- Do not cut off tinned ends.
- Lamps must be installed only in accordance with UNECE regulations.



www.myKAMAR.com

PHOTO AND TECHNICAL DRAWING:

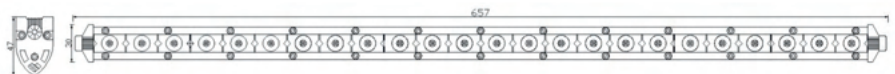

TECHNICAL SPECIFICATIONS:

MATERIAL	LED/LM QUANTITY	MOUNTING	WIRE	FUNCTION	WATT	VOLTAGE	CERTIFICATES	PACKING/WEIGHT
• Lens: PC • Housing: AL	• 24 LED • 2400LM	• screws	• 0.3 m	• work light • flood	• 34,8W	• 12/24V	• ECE R10	• cart. dim.: 72x29x20cm • weight: 14kg • 20 pcs/bulk box

We reserve the right to change technical data and any errors. Photos and specifications are for reference only, and the actual product may vary slightly. Reproduction in whole or parts of the catalog without written authorization is prohibited.



REFERENCE:
LB0105

PANEL LED 30XLED

WARNINGS FOR THE USER:

- Do not look directly into the light - it may cause damage or even loss of vision.
- Install only in specialized workshops or professional services.
- Use in open space only.
- Use in accordance to the purpose.

INSTALLATION INSTRUCTIONS:

- It should be used exclusively in accordance with intended use.
- Mount exclusively in specialized workshops.
- The connection between the lamp and vehicle's installation should be isolated with heat-shrink tube or alternatively with isolating tape to avoid getting water and moisture to the copper wire of the lamp which can damage electronic components. When it comes to lamp and plug, the plug should be mounted safely.
- Do not cut off tinned ends.
- Lamps must be installed only in accordance with UNECE regulations.



www.myKAMAR.com

PHOTO AND TECHNICAL DRAWING:

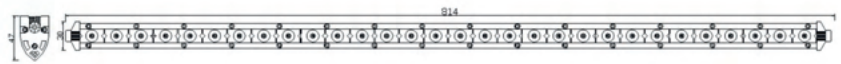

TECHNICAL SPECIFICATIONS:

MATERIAL	LED/LM QUANTITY	MOUNTING	WIRE	FUNCTION	WATT	VOLTAGE	CERTIFICATES	PACKING/WEIGHT
• Lens: PC • Housing: AL	• 30 LED • 3000LM	• screws	• 0.3 m	• work light • flood	• 44W	• 12/24V	• ECE R10	• cart. dim.: 72x29x20cm • weight: 14kg • 20 pcs/bulk box

We reserve the right to change technical data and any errors. Photos and specifications are for reference only, and the actual product may vary slightly. Reproduction in whole or parts of the catalog without written authorization is prohibited.



REFERENCE:
LB0106

PANEL LED 36XLED

WARNINGS FOR THE USER:

- Do not look directly into the light - it may cause damage or even loss of vision.
- Install only in specialized workshops or professional services.
- Use in open space only.
- Use in accordance to the purpose.

INSTALLATION INSTRUCTIONS:

- It should be used exclusively in accordance with intended use.
- Mount exclusively in specialized workshops.
- The connection between the lamp and vehicle's installation should be isolated with heat-shrink tube or alternatively with isolating tape to avoid getting water and moisture to the copper wire of the lamp which can damage electronic components. When it comes to lamp and plug, the plug should be mounted safely.
- Do not cut off tinned ends.
- Lamps must be installed only in accordance with UNECE regulations.



www.myKAMAR.com

PHOTO AND TECHNICAL DRAWING:



TECHNICAL SPECIFICATIONS:

MATERIAL	LED/LM QUANTITY	MOUNTING	WIRE	FUNCTION	WATT	VOLTAGE	CERTIFICATES	PACKING/WEIGHT
• Lens: PC • Housing: AL	• 36 LED • 3600LM	• screws	• 0.3 m	• work light • flood	• 53W	• 12/24V	• ECE R10	• cart. dim.: 102x32x22cm • weight: 13kg • 20 pcs/bulk box

We reserve the right to change technical data and any errors. Photos and specifications are for reference only, and the actual product may vary slightly. Reproduction in whole or parts of the catalog without written authorization is prohibited.



**REFERENCE:
LB0107**

PANEL LED 42XLED

WARNINGS FOR THE USER:

- Do not look directly into the light - it may cause damage or even loss of vision.
- Install only in specialized workshops or professional services.
- Use in open space only.
- Use in accordance to the purpose.

INSTALLATION INSTRUCTIONS:

- It should be used exclusively in accordance with intended use.
- Mount exclusively in specialized workshops.
- The connection between the lamp and vehicle's installation should be isolated with heat-shrink tube or alternatively with isolating tape to avoid getting water and moisture to the copper wire of the lamp which can damage electronic components. When it comes to lamp and plug, the plug should be mounted safely.
- Do not cut off tinned ends.
- Lamps must be installed only in accordance with UNECE regulations.



www.myKAMAR.com

PHOTO AND TECHNICAL DRAWING:



TECHNICAL SPECIFICATIONS:

MATERIAL	LED/LM QUANTITY	MOUNTING	WIRE	FUNCTION	WATT	VOLTAGE	CERTIFICATES	PACKING/WEIGHT
• Lens: PC • Housing: AL	• 42 LED • 4200LM	• screws	• 0.3 m	• work light • flood	• 62W	• 12/24V	• ECE R10	• cart. dim.: 120x27x21cm • weight: 22kg • 20 pcs/bulk box

We reserve the right to change technical data and any errors. Photos and specifications are for reference only, and the actual product may vary slightly. Reproduction in whole or parts of the catalog without written authorization is prohibited.



**REFERENCE:
LB0108**

PANEL LED 48XLED

WARNINGS FOR THE USER:

- Do not look directly into the light - it may cause damage or even loss of vision.
- Install only in specialized workshops or professional services.
- Use in open space only.
- Use in accordance to the purpose.

INSTALLATION INSTRUCTIONS:

- It should be used exclusively in accordance with intended use.
- Mount exclusively in specialized workshops.
- The connection between the lamp and vehicle's installation should be isolated with heat-shrink tube or alternatively with isolating tape to avoid getting water and moisture to the copper wire of the lamp which can damage electronic components. When it comes to lamp and plug, the plug should be mounted safely.
- Do not cut off tinned ends.
- Lamps must be installed only in accordance with UNECE regulations.



www.myKAMAR.com

PHOTO AND TECHNICAL DRAWING:



TECHNICAL SPECIFICATIONS:

MATERIAL	LED/LM QUANTITY	MOUNTING	WIRE	FUNCTION	WATT	VOLTAGE	CERTIFICATES	PACKING/WEIGHT
• Lens: PC • Housing: AL	• 48 LED • 4800LM	• screws	• 0.3 m	• work light • flood	• 71W	• 12/24V	• ECE R10	• cart. dim.: 138x33x23cm • weight: 23kg • 20 pcs/bulk box

We reserve the right to change technical data and any errors. Photos and specifications are for reference only, and the actual product may vary slightly. Reproduction in whole or parts of the catalog without written authorization is prohibited.



REFERENCE:
LB0109V

PANEL LED 108XLED CURVE

WARNINGS FOR THE USER:

- Do not look directly into the light - it may cause damage or even loss of vision.
- Install only in specialized workshops or professional services.
- Use in open space only.
- Use in accordance to the purpose.

INSTALLATION INSTRUCTIONS:

- It should be used exclusively in accordance with intended use.
- Mount exclusively in specialized workshops.
- The connection between the lamp and vehicle's installation should be isolated with heat-shrink tube or alternatively with isolating tape to avoid getting water and moisture to the copper wire of the lamp which can damage electronic components. When it comes to lamp and plug, the plug should be mounted safely.
- Do not cut off tinned ends.
- Lamps must be installed only in accordance with UNECE regulations.



www.myKAMAR.com

PHOTO AND TECHNICAL DRAWING:

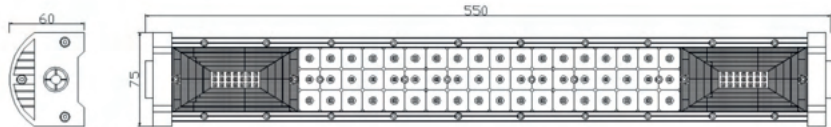

TECHNICAL SPECIFICATIONS:

MATERIAL	LED/LM QUANTITY	MOUNTING	WIRE	FUNCTION	WATT	VOLTAGE	CERTIFICATES	PACKING/WEIGHT
• Lens: PC • Housing: AL	• 96 LED • 6600 LM	• screws	• 0.3 m	• work light • flood	• 71W	• 12/24V	• ECE R10	• cart. dim.: 72x48x29cm • weight: 13kg • 8 pcs/bulk box

We reserve the right to change technical data and any errors. Photos and specifications are for reference only, and the actual product may vary slightly. Reproduction in whole or parts of the catalog without written authorization is prohibited.



REFERENCE:
LB0110V

PANEL LED 141XLED CURVE

WARNINGS FOR THE USER:

- Do not look directly into the light - it may cause damage or even loss of vision.
- Install only in specialized workshops or professional services.
- Use in open space only.
- Use in accordance to the purpose.

INSTALLATION INSTRUCTIONS:

- It should be used exclusively in accordance with intended use.
- Mount exclusively in specialized workshops.
- The connection between the lamp and vehicle's installation should be isolated with heat-shrink tube or alternatively with isolating tape to avoid getting water and moisture to the copper wire of the lamp which can damage electronic components. When it comes to lamp and plug, the plug should be mounted safely.
- Do not cut off tinned ends.
- Lamps must be installed only in accordance with UNECE regulations.



www.myKAMAR.com

PHOTO AND TECHNICAL DRAWING:

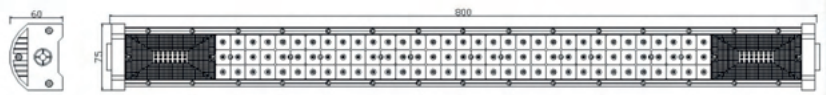

TECHNICAL SPECIFICATIONS:

MATERIAL	LED/LM QUANTITY	MOUNTING	WIRE	FUNCTION	WATT	VOLTAGE	CERTIFICATES	PACKING/WEIGHT
• Lens: PC • Housing: AL	• 141 LED • 7700 LM	• screws	• 0.3 m	• work light • flood	• 101W	• 12/24V	• ECE R10	• cart. dim.: 107x37x29cm • weight: 13kg • 6 pcs/bulk box

We reserve the right to change technical data and any errors. Photos and specifications are for reference only, and the actual product may vary slightly. Reproduction in whole or parts of the catalog without written authorization is prohibited.



REFERENCE:
LB011V

PANEL LED 186XLED CURVE

WARNINGS FOR THE USER:

- Do not look directly into the light - it may cause damage or even loss of vision.
- Install only in specialized workshops or professional services.
- Use in open space only.
- Use in accordance to the purpose.

INSTALLATION INSTRUCTIONS:

- It should be used exclusively in accordance with intended use.
- Mount exclusively in specialized workshops.
- The connection between the lamp and vehicle's installation should be isolated with heat-shrink tube or alternatively with isolating tape to avoid getting water and moisture to the copper wire of the lamp which can damage electronic components. When it comes to lamp and plug, the plug should be mounted safely.
- Do not cut off tinned ends.
- Lamps must be installed only in accordance with UNECE regulations.



www.myKAMAR.com

PHOTO AND TECHNICAL DRAWING:

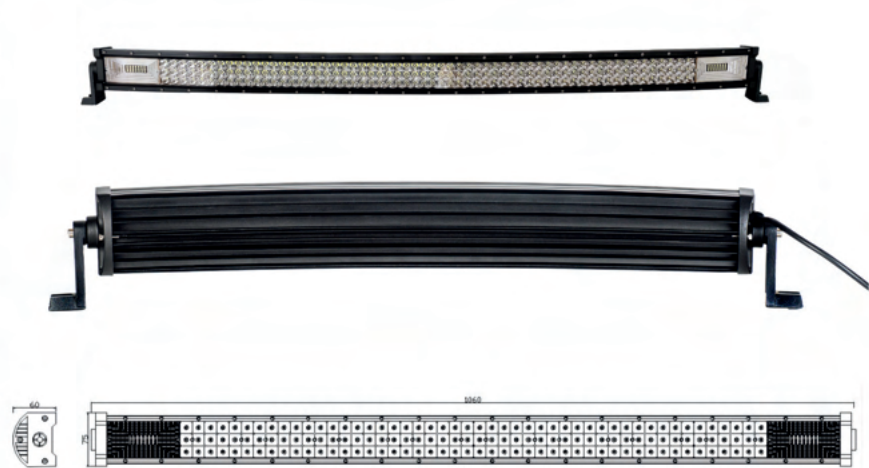

TECHNICAL SPECIFICATIONS:

MATERIAL	LED/LM QUANTITY	MOUNTING	WIRE	FUNCTION	WATT	VOLTAGE	CERTIFICATES	PACKING/WEIGHT
• Lens: PC • Housing: AL	• 186 LED • 9500 LM	• screws	• 0.3 m	• work light • flood	• 140W	• 12/24V	• ECE R10	• cart. dim.: 127x26x29cm • weight: 11kg • 4 pcs/bulk box

We reserve the right to change technical data and any errors. Photos and specifications are for reference only, and the actual product may vary slightly. Reproduction in whole or parts of the catalog without written authorization is prohibited.



REFERENCE:
LB012V

PANEL LED 222XLED CURVE

WARNINGS FOR THE USER:

- Do not look directly into the light - it may cause damage or even loss of vision.
- Install only in specialized workshops or professional services.
- Use in open space only.
- Use in accordance to the purpose.

INSTALLATION INSTRUCTIONS:

- It should be used exclusively in accordance with intended use.
- Mount exclusively in specialized workshops.
- The connection between the lamp and vehicle's installation should be isolated with heat-shrink tube or alternatively with isolating tape to avoid getting water and moisture to the copper wire of the lamp which can damage electronic components. When it comes to lamp and plug, the plug should be mounted safely.
- Do not cut off tinned ends.
- Lamps must be installed only in accordance with UNECE regulations.

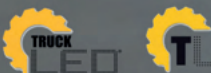

www.myKAMAR.com

PHOTO AND TECHNICAL DRAWING:

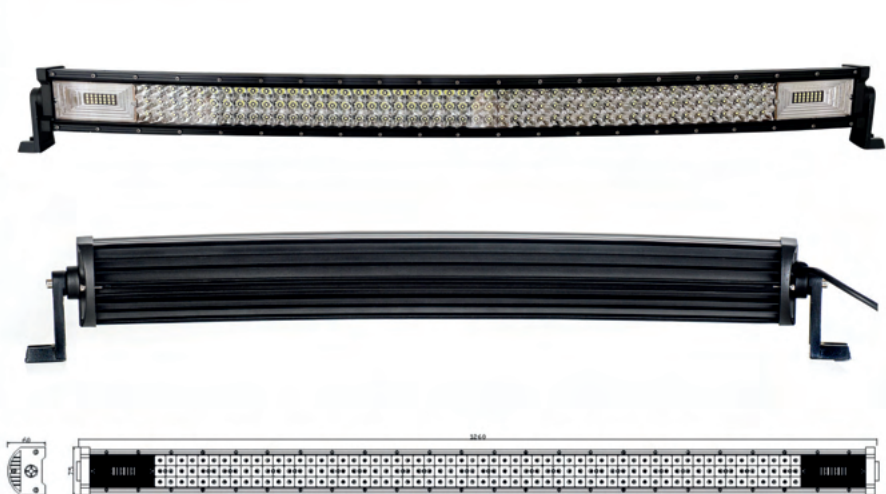

TECHNICAL SPECIFICATIONS:

MATERIAL	LED/LM QUANTITY	MOUNTING	WIRE	FUNCTION	WATT	VOLTAGE	CERTIFICATES	PACKING/WEIGHT
• Lens: PC • Housing: AL	• 222LED • 12500LM	• handle	• 0.3 m	• work light • flood	• 165W	• 12/48V	• ECE R10	• cart. dim.: 138x33x23cm • weight: 14kg • 4 pcs/bulk box

We reserve the right to change technical data and any errors. Photos and specifications are for reference only, and the actual product may vary slightly. Reproduction in whole or parts of the catalog without written authorization is prohibited.



REFERENCE:
LB0113V

PANEL LED 231XLED CURVE

WARNINGS FOR THE USER:

- Do not look directly into the light - it may cause damage or even loss of vision.
- Install only in specialized workshops or professional services.
- Use in open space only.
- Use in accordance to the purpose.

INSTALLATION INSTRUCTIONS:

- It should be used exclusively in accordance with intended use.
- Mount exclusively in specialized workshops.
- The connection between the lamp and vehicle's installation should be isolated with heat-shrink tube or alternatively with isolating tape to avoid getting water and moisture to the copper wire of the lamp which can damage electronic components. When it comes to lamp and plug, the plug should be mounted safely.
- Do not cut off tinned ends.
- Lamps must be installed only in accordance with UNECE regulations.



www.myKAMAR.com

PHOTO AND TECHNICAL DRAWING:

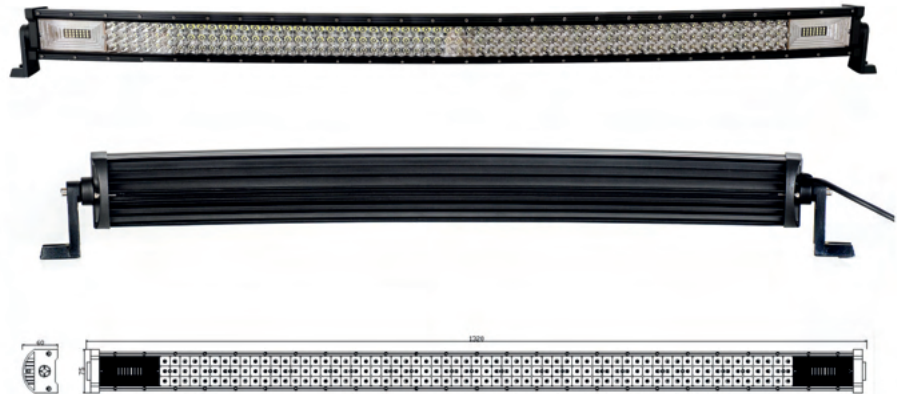

TECHNICAL SPECIFICATIONS:

MATERIAL	LED/LM QUANTITY	MOUNTING	WIRE	FUNCTION	WATT	VOLTAGE	CERTIFICATES	PACKING/WEIGHT
• Lens: PC • Housing: AL	• 231LED • 12800LM	• handle	• 0.3 m	• work light • flood	• 175W	• 12/48V	• ECE R10	• cart. dim.: 138x33x23cm • weight: 13kg • 4 pcs/bulk box

We reserve the right to change technical data and any errors. Photos and specifications are for reference only, and the actual product may vary slightly. Reproduction in whole or parts of the catalog without written authorization is prohibited.



REFERENCE:
LB0114

PANEL LED 12XLED

WARNINGS FOR THE USER:

- Do not look directly into the light - it may cause damage or even loss of vision.
- Install only in specialized workshops or professional services.
- Use in open space only.
- Use in accordance to the purpose.

INSTALLATION INSTRUCTIONS:

- It should be used exclusively in accordance with intended use.
- Mount exclusively in specialized workshops.
- The connection between the lamp and vehicle's installation should be isolated with heat-shrink tube or alternatively with isolating tape to avoid getting water and moisture to the copper wire of the lamp which can damage electronic components. When it comes to lamp and plug, the plug should be mounted safely.
- Do not cut off tinned ends.
- Lamps must be installed only in accordance with UNECE regulations.

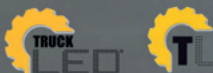

www.myKAMAR.com

PHOTO AND TECHNICAL DRAWING:

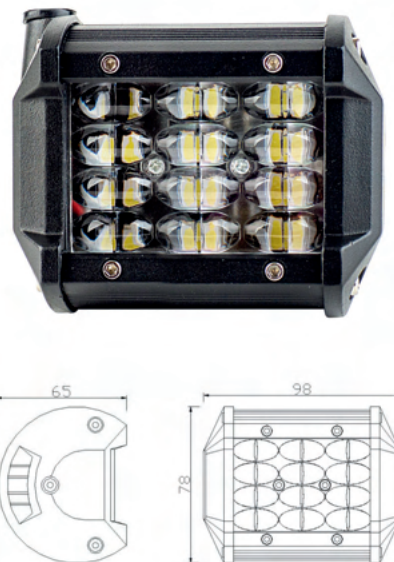

TECHNICAL SPECIFICATIONS:

MATERIAL	LED/LM QUANTITY	MOUNTING	WIRE	FUNCTION	WATT	VOLTAGE	CERTIFICATES	PACKING/WEIGHT
• Lens: PC • Housing: AL	• 12 LED • 1000LM	• screws	• 0.3 m	• work light • flood	• 12.8W	• 12/24V	• ECE R10	• cart. dim.: 63x38x20cm • weight: 1.8kg • 40 pcs/bulk box

We reserve the right to change technical data and any errors. Photos and specifications are for reference only, and the actual product may vary slightly. Reproduction in whole or parts of the catalog without written authorization is prohibited.



**REFERENCE:
LB0115**

PANEL LED 24XLED

WARNINGS FOR THE USER:

- Do not look directly into the light - it may cause damage or even loss of vision.
- Install only in specialized workshops or professional services.
- Use in open space only.
- Use in accordance to the purpose.

INSTALLATION INSTRUCTIONS:

- It should be used exclusively in accordance with intended use.
- Mount exclusively in specialized workshops.
- The connection between the lamp and vehicle's installation should be isolated with heat-shrink tube or alternatively with isolating tape to avoid getting water and moisture to the copper wire of the lamp which can damage electronic components. When it comes to lamp and plug, the plug should be mounted safely.
- Do not cut off tinned ends.
- Lamps must be installed only in accordance with UNECE regulations.



www.myKAMAR.com

PHOTO AND TECHNICAL DRAWING:

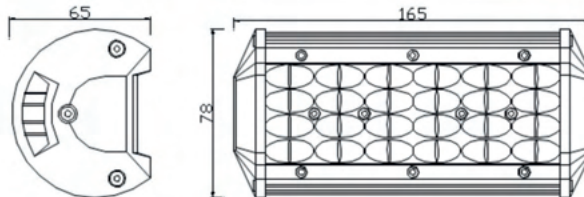

TECHNICAL SPECIFICATIONS:



MATERIAL	LED/LM QUANTITY	MOUNTING	WIRE	FUNCTION	WATT	VOLTAGE	CERTIFICATES	PACKING/WEIGHT
• Lens: PC • Housing: AL	• 24 LED • 2000LM	• screws	• 0.3 m	• work light • flood	• 24,6W	• 12/24V	• ECE R10	• cart. dim.: 60x57x29cm • weight: 13kg • 20 pcs/bulk box

We reserve the right to change technical data and any errors. Photos and specifications are for reference only, and the actual product may vary slightly. Reproduction in whole or parts of the catalog without written authorization is prohibited.



**REFERENCE:
LB0116**

PANEL LED 36XLED

WARNINGS FOR THE USER:

- Do not look directly into the light - it may cause damage or even loss of vision.
- Install only in specialized workshops or professional services.
- Use in open space only.
- Use in accordance to the purpose.

INSTALLATION INSTRUCTIONS:

- It should be used exclusively in accordance with intended use.
- Mount exclusively in specialized workshops.
- The connection between the lamp and vehicle's installation should be isolated with heat-shrink tube or alternatively with isolating tape to avoid getting water and moisture to the copper wire of the lamp which can damage electronic components. When it comes to lamp and plug, the plug should be mounted safely.
- Do not cut off tinned ends.
- Lamps must be installed only in accordance with UNECE regulations.

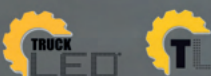

www.myKAMAR.com

PHOTO AND TECHNICAL DRAWING:

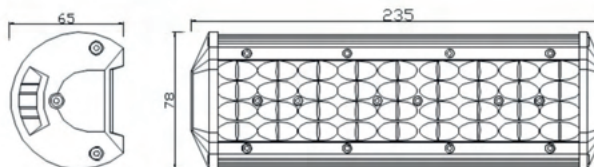

TECHNICAL SPECIFICATIONS:



MATERIAL	LED/LM QUANTITY	MOUNTING	WIRE	FUNCTION	WATT	VOLTAGE	CERTIFICATES	PACKING/WEIGHT
• Lens: PC • Housing: AL	• 36 LED • 2800LM	• screws	• 0.3 m	• work light • flood	• 35,9W	• 12/24V	• ECE R10	• cart. dim.: 60x56x36cm • weight: 17kg • 20 pcs/bulk box

We reserve the right to change technical data and any errors. Photos and specifications are for reference only, and the actual product may vary slightly. Reproduction in whole or parts of the catalog without written authorization is prohibited.



REFERENCE: LB0117

PANEL LED 48XLED

WARNINGS FOR THE USER:

- Do not look directly into the light - it may cause damage or even loss of vision.
- Install only in specialized workshops or professional services.
- Use in open space only.
- Use in accordance to the purpose.

INSTALLATION INSTRUCTIONS:

- It should be used exclusively in accordance with intended use.
- Mount exclusively in specialized workshops.
- The connection between the lamp and vehicle's installation should be isolated with heat-shrink tube or alternatively with isolating tape to avoid getting water and moisture to the copper wire of the lamp which can damage electronic components. When it comes to lamp and plug, the plug should be mounted safely.
- Do not cut off tinned ends.
- Lamps must be installed only in accordance with UNECE regulations.



www.myKAMAR.com

PHOTO AND TECHNICAL DRAWING:

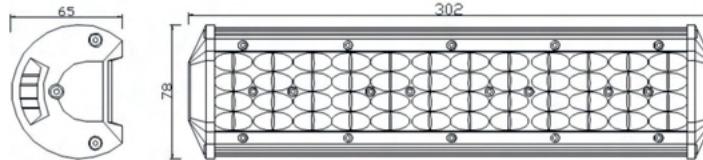

TECHNICAL SPECIFICATIONS:

MATERIAL	LED/LM QUANTITY	MOUNTING	WIRE	FUNCTION	WATT	VOLTAGE	CERTIFICATES	PACKING/WEIGHT
• Lens: PC • Housing: AL	• 48 LED • 3800LM	• screws	• 0.3 m	• work light • flood	• 46W	• 12/24V	• ECE R10	• cart. dim.: 60x43x29cm • weight: 11kg • 10 pcs/bulk box

We reserve the right to change technical data and any errors. Photos and specifications are for reference only, and the actual product may vary slightly. Reproduction in whole or parts of the catalog without written authorization is prohibited.



REFERENCE: LB0118

PANEL LED 60XLED

WARNINGS FOR THE USER:

- Do not look directly into the light - it may cause damage or even loss of vision.
- Install only in specialized workshops or professional services.
- Use in open space only.
- Use in accordance to the purpose.

INSTALLATION INSTRUCTIONS:

- It should be used exclusively in accordance with intended use.
- Mount exclusively in specialized workshops.
- The connection between the lamp and vehicle's installation should be isolated with heat-shrink tube or alternatively with isolating tape to avoid getting water and moisture to the copper wire of the lamp which can damage electronic components. When it comes to lamp and plug, the plug should be mounted safely.
- Do not cut off tinned ends.
- Lamps must be installed only in accordance with UNECE regulations.



www.myKAMAR.com

PHOTO AND TECHNICAL DRAWING:

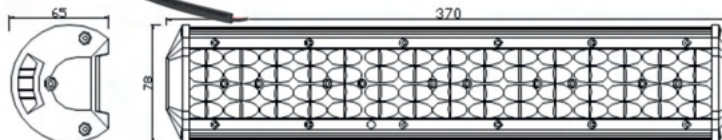

TECHNICAL SPECIFICATIONS:

MATERIAL	LED/LM QUANTITY	MOUNTING	WIRE	FUNCTION	WATT	VOLTAGE	CERTIFICATES	PACKING/WEIGHT
• Lens: PC • Housing: AL	• 60 LED • 4800LM	• screws	• 0.3 m	• work light • flood	• 59W	• 12/24V	• ECE R10	• cart. dim.: 60x50x29cm • weight: 13kg • 10 pcs/bulk box

We reserve the right to change technical data and any errors. Photos and specifications are for reference only, and the actual product may vary slightly. Reproduction in whole or parts of the catalog without written authorization is prohibited.



**REFERENCE:
LB0119**

PANEL LED 72XLED

WARNINGS FOR THE USER:

- Do not look directly into the light - it may cause damage or even loss of vision.
- Install only in specialized workshops or professional services.
- Use in open space only.
- Use in accordance to the purpose.

INSTALLATION INSTRUCTIONS:

- It should be used exclusively in accordance with intended use.
- Mount exclusively in specialized workshops.
- The connection between the lamp and vehicle's installation should be isolated with heat-shrink tube or alternatively with isolating tape to avoid getting water and moisture to the copper wire of the lamp which can damage electronic components. When it comes to lamp and plug, the plug should be mounted safely.
- Do not cut off tinned ends.
- Lamps must be installed only in accordance with UNECE regulations.



www.myKAMAR.com

PHOTO AND TECHNICAL DRAWING:

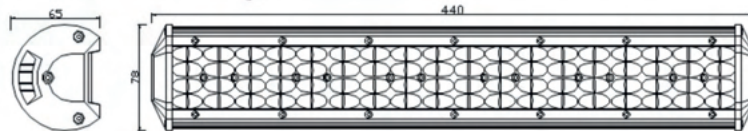

TECHNICAL SPECIFICATIONS:

MATERIAL	LED/LM QUANTITY	MOUNTING	WIRE	FUNCTION	WATT	VOLTAGE	CERTIFICATES	PACKING/WEIGHT
• Lens: PC • Housing: AL	• 72 LED • 5800LM	• screws	• 0.3 m	• work light • flood	• 72W	• 12/24V	• ECE R10	• cart. dim.: 60x57x29cm • weight: 14kg • 10 pcs/bulk box

We reserve the right to change technical data and any errors. Photos and specifications are for reference only, and the actual product may vary slightly. Reproduction in whole or parts of the catalog without written authorization is prohibited.



**REFERENCE:
LB0120**

PANEL LED 40XLED

WARNINGS FOR THE USER:

- Do not look directly into the light - it may cause damage or even loss of vision.
- Install only in specialized workshops or professional services.
- Use in open space only.
- Use in accordance to the purpose.

INSTALLATION INSTRUCTIONS:

- It should be used exclusively in accordance with intended use.
- Mount exclusively in specialized workshops.
- The connection between the lamp and vehicle's installation should be isolated with heat-shrink tube or alternatively with isolating tape to avoid getting water and moisture to the copper wire of the lamp which can damage electronic components. When it comes to lamp and plug, the plug should be mounted safely.
- Do not cut off tinned ends.
- Lamps must be installed only in accordance with UNECE regulations.



www.myKAMAR.com

PHOTO AND TECHNICAL DRAWING:

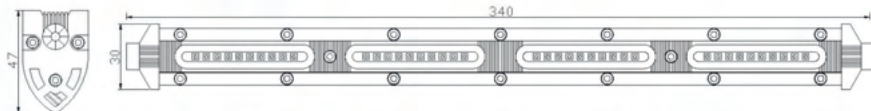

TECHNICAL SPECIFICATIONS:

MATERIAL	LED/LM QUANTITY	MOUNTING	WIRE	FUNCTION	WATT	VOLTAGE	CERTIFICATES	PACKING/WEIGHT
• Lens: PC • Housing: AL	• 40 LED • 2200LM	• screws	• 0.3 m	• work light • flood	• 28W	• 12/24V	• ECE R10	• cart. dim.: 59x40x25cm • weight: 21kg • 50 pcs/bulk box

We reserve the right to change technical data and any errors. Photos and specifications are for reference only, and the actual product may vary slightly. Reproduction in whole or parts of the catalog without written authorization is prohibited.



REFERENCE:
LB0121

PANEL LED 60XLED

WARNINGS FOR THE USER:

- Do not look directly into the light - it may cause damage or even loss of vision.
- Install only in specialized workshops or professional services.
- Use in open space only.
- Use in accordance to the purpose.

INSTALLATION INSTRUCTIONS:

- It should be used exclusively in accordance with intended use.
- Mount exclusively in specialized workshops.
- The connection between the lamp and vehicle's installation should be isolated with heat-shrink tube or alternatively with isolating tape to avoid getting water and moisture to the copper wire of the lamp which can damage electronic components. When it comes to lamp and plug, the plug should be mounted safely.
- Do not cut off tinned ends.
- Lamps must be installed only in accordance with UNECE regulations.



www.myKAMAR.com

PHOTO AND TECHNICAL DRAWING:

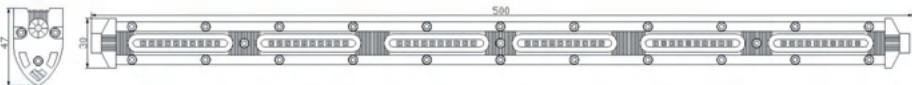

TECHNICAL SPECIFICATIONS:

MATERIAL	LED/LM QUANTITY	MOUNTING	WIRE	FUNCTION	WATT	VOLTAGE	CERTIFICATES	PACKING/WEIGHT
• Lens: PC • Housing: AL	• 60 LED • 3300LM	• screws	• 0.3 m	• work light • flood	• 45W	• 12/24V	• ECE R10	• cart. dim.: 56x41x31,5cm • weight: 22kg • 40 pcs/bulk box

We reserve the right to change technical data and any errors. Photos and specifications are for reference only, and the actual product may vary slightly. Reproduction in whole or parts of the catalog without written authorization is prohibited.



REFERENCE:
LB0122

PANEL LED 80XLED

WARNINGS FOR THE USER:

- Do not look directly into the light - it may cause damage or even loss of vision.
- Install only in specialized workshops or professional services.
- Use in open space only.
- Use in accordance to the purpose.

INSTALLATION INSTRUCTIONS:

- It should be used exclusively in accordance with intended use.
- Mount exclusively in specialized workshops.
- The connection between the lamp and vehicle's installation should be isolated with heat-shrink tube or alternatively with isolating tape to avoid getting water and moisture to the copper wire of the lamp which can damage electronic components. When it comes to lamp and plug, the plug should be mounted safely.
- Do not cut off tinned ends.
- Lamps must be installed only in accordance with UNECE regulations.



www.myKAMAR.com

PHOTO AND TECHNICAL DRAWING:

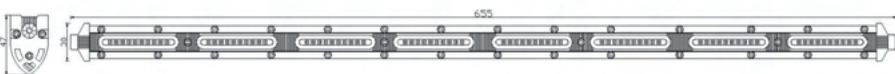

TECHNICAL SPECIFICATIONS:

MATERIAL	LED/LM QUANTITY	MOUNTING	WIRE	FUNCTION	WATT	VOLTAGE	CERTIFICATES	PACKING/WEIGHT
• Lens: PC • Housing: AL	• 80 LED • 4400LM	• screws	• 0.3 m	• work light • flood	• 60W	• 12/24V	• ECE R10	• cart. dim.: 72x29x20cm • weight: 14kg • 20 pcs/bulk box

We reserve the right to change technical data and any errors. Photos and specifications are for reference only, and the actual product may vary slightly. Reproduction in whole or parts of the catalog without written authorization is prohibited.



REFERENCE:
LB0123

PANEL LED 2XCOB

WARNINGS FOR THE USER:

- Do not look directly into the light - it may cause damage or even loss of vision.
- Install only in specialized workshops or professional services.
- Use in open space only.
- Use in accordance to the purpose.

INSTALLATION INSTRUCTIONS:

- It should be used exclusively in accordance with intended use.
- Mount exclusively in specialized workshops.
- The connection between the lamp and vehicle's installation should be isolated with heat-shrink tube or alternatively with isolating tape to avoid getting water and moisture to the copper wire of the lamp which can damage electronic components. When it comes to lamp and plug, the plug should be mounted safely.
- Do not cut off tinned ends.
- Lamps must be installed only in accordance with UNECE regulations.



www.myKAMAR.com

PHOTO AND TECHNICAL DRAWING:

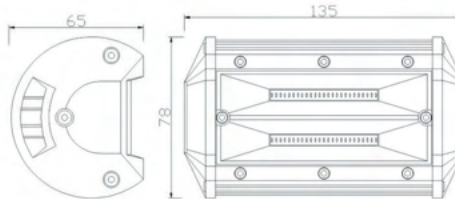

TECHNICAL SPECIFICATIONS:

MATERIAL	LED/LM QUANTITY	MOUNTING	WIRE	FUNCTION	WATT	VOLTAGE	CERTIFICATES	PACKING/WEIGHT
• Lens: PC • Housing: AL	• 48 LED • 1600LM	• screws	• 0.3 m	• work light • flood	• 18,6W	• 12/24V	• ECE R10	• cart. dim.: 43x42x21cm • weight: 11kg • 25 pcs/bulk box

We reserve the right to change technical data and any errors. Photos and specifications are for reference only, and the actual product may vary slightly. Reproduction in whole or parts of the catalog without written authorization is prohibited.



REFERENCE:
LB0124

PANEL LED 4XCOB

WARNINGS FOR THE USER:

- Do not look directly into the light - it may cause damage or even loss of vision.
- Install only in specialized workshops or professional services.
- Use in open space only.
- Use in accordance to the purpose.

INSTALLATION INSTRUCTIONS:

- It should be used exclusively in accordance with intended use.
- Mount exclusively in specialized workshops.
- The connection between the lamp and vehicle's installation should be isolated with heat-shrink tube or alternatively with isolating tape to avoid getting water and moisture to the copper wire of the lamp which can damage electronic components. When it comes to lamp and plug, the plug should be mounted safely.
- Do not cut off tinned ends.
- Lamps must be installed only in accordance with UNECE regulations.



www.myKAMAR.com

PHOTO AND TECHNICAL DRAWING:

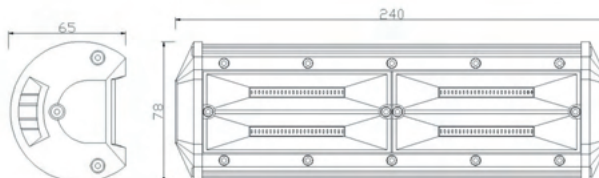

TECHNICAL SPECIFICATIONS:

MATERIAL	LED/LM QUANTITY	MOUNTING	WIRE	FUNCTION	WATT	VOLTAGE	CERTIFICATES	PACKING/WEIGHT
• Lens: PC • Housing: AL	• 96 LED • 3000LM	• screws	• 0.3 m	• work light • flood	• 38W	• 12/24V	• ECE R10	• cart. dim.: 60x42x21cm • weight: 16kg • 20 pcs/bulk box

We reserve the right to change technical data and any errors. Photos and specifications are for reference only, and the actual product may vary slightly. Reproduction in whole or parts of the catalog without written authorization is prohibited.



**REFERENCE:
LB0125**

PANEL LED 6XCOB

WARNINGS FOR THE USER:

- Do not look directly into the light - it may cause damage or even loss of vision.
- Install only in specialized workshops or professional services.
- Use in open space only.
- Use in accordance to the purpose.

INSTALLATION INSTRUCTIONS:

- It should be used exclusively in accordance with intended use.
- Mount exclusively in specialized workshops.
- The connection between the lamp and vehicle's installation should be isolated with heat-shrink tube or alternatively with isolating tape to avoid getting water and moisture to the copper wire of the lamp which can damage electronic components. When it comes to lamp and plug, the plug should be mounted safely.
- Do not cut off tinned ends.
- Lamps must be installed only in accordance with UNECE regulations.



www.myKAMAR.com

PHOTO AND TECHNICAL DRAWING:

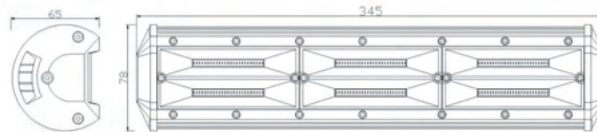

TECHNICAL SPECIFICATIONS:

MATERIAL	LED/LM QUANTITY	MOUNTING	WIRE	FUNCTION	WATT	VOLTAGE	CERTIFICATES	PACKING/WEIGHT
• Lens: PC • Housing: AL	• 96 LED • 3000 LM	• screws	• 0.3 m	• work light • flood	• 60W	• 12/24V	• ECE R10	• cart. dim.: 60x50x29cm • weight: 11kg • 10 pcs/bulk box

We reserve the right to change technical data and any errors. Photos and specifications are for reference only, and the actual product may vary slightly. Reproduction in whole or parts of the catalog without written authorization is prohibited.



**REFERENCE:
LB0126**

PANEL LED 8XCOB

WARNINGS FOR THE USER:

- Do not look directly into the light - it may cause damage or even loss of vision.
- Install only in specialized workshops or professional services.
- Use in open space only.
- Use in accordance to the purpose.

INSTALLATION INSTRUCTIONS:

- It should be used exclusively in accordance with intended use.
- Mount exclusively in specialized workshops.
- The connection between the lamp and vehicle's installation should be isolated with heat-shrink tube or alternatively with isolating tape to avoid getting water and moisture to the copper wire of the lamp which can damage electronic components. When it comes to lamp and plug, the plug should be mounted safely.
- Do not cut off tinned ends.
- Lamps must be installed only in accordance with UNECE regulations.



www.myKAMAR.com

PHOTO AND TECHNICAL DRAWING:

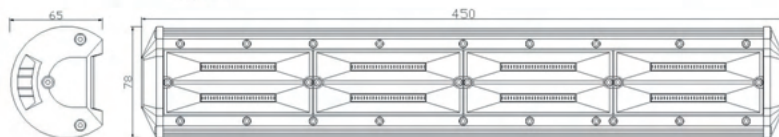

TECHNICAL SPECIFICATIONS:

MATERIAL	LED/LM QUANTITY	MOUNTING	WIRE	FUNCTION	WATT	VOLTAGE	CERTIFICATES	PACKING/WEIGHT
• Lens: PC • Housing: AL	• 192 LED • 6300 LM	• screws	• 0.3 m	• work light • flood	• 78W	• 12/24V	• ECE R10	• cart. dim.: 60x57x29cm • weight: 13kg • 10 pcs/bulk box

We reserve the right to change technical data and any errors. Photos and specifications are for reference only, and the actual product may vary slightly. Reproduction in whole or parts of the catalog without written authorization is prohibited.



**REFERENCE:
LB0127**

PANEL LED 10XC0B

WARNINGS FOR THE USER:

- Do not look directly into the light - it may cause damage or even loss of vision.
- Install only in specialized workshops or professional services.
- Use in open space only.
- Use in accordance to the purpose.

INSTALLATION INSTRUCTIONS:

- It should be used exclusively in accordance with intended use.
- Mount exclusively in specialized workshops.
- The connection between the lamp and vehicle's installation should be isolated with heat-shrink tube or alternatively with isolating tape to avoid getting water and moisture to the copper wire of the lamp which can damage electronic components. When it comes to lamp and plug, the plug should be mounted safely.
- Do not cut off tinned ends.
- Lamps must be installed only in accordance with UNECE regulations.



www.myKAMAR.com

PHOTO AND TECHNICAL DRAWING:

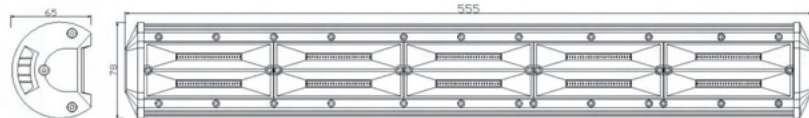
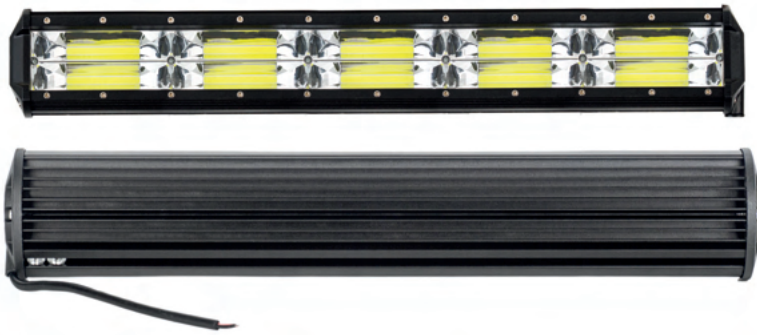

TECHNICAL SPECIFICATIONS:

MATERIAL	LED/LM QUANTITY	MOUNTING	WIRE	FUNCTION	WATT	VOLTAGE	CERTIFICATES	PACKING/WEIGHT
• Lens: PC • Housing: AL	• 240 LED • 8000 LM	• screws	• 0.3 m	• work light • flood	• 98W	• 12/24V	• ECE R10	• cart. dim.: 72x48x29cm • weight: 12 kg • 8 pcs/bulk box

We reserve the right to change technical data and any errors. Photos and specifications are for reference only, and the actual product may vary slightly. Reproduction in whole or parts of the catalog without written authorization is prohibited.



**REFERENCE:
LB0128**

PANEL LED 12XC0B

WARNINGS FOR THE USER:

- Do not look directly into the light - it may cause damage or even loss of vision.
- Install only in specialized workshops or professional services.
- Use in open space only.
- Use in accordance to the purpose.

INSTALLATION INSTRUCTIONS:

- It should be used exclusively in accordance with intended use.
- Mount exclusively in specialized workshops.
- The connection between the lamp and vehicle's installation should be isolated with heat-shrink tube or alternatively with isolating tape to avoid getting water and moisture to the copper wire of the lamp which can damage electronic components. When it comes to lamp and plug, the plug should be mounted safely.
- Do not cut off tinned ends.
- Lamps must be installed only in accordance with UNECE regulations.



www.myKAMAR.com

PHOTO AND TECHNICAL DRAWING:



TECHNICAL SPECIFICATIONS:

MATERIAL	LED/LM QUANTITY	MOUNTING	WIRE	FUNCTION	WATT	VOLTAGE	CERTIFICATES	PACKING/WEIGHT
• Lens: PC • Housing: AL	• 288 LED • 9500 LM	• screws	• 0.3 m	• work light • flood	• 120W	• 12/24V	• ECE R10	• cart. dim.: 85x48x29cm • weight: 16 kg • 8 pcs/bulk box

We reserve the right to change technical data and any errors. Photos and specifications are for reference only, and the actual product may vary slightly. Reproduction in whole or parts of the catalog without written authorization is prohibited.

KAMAR S.K.A.

**Al. Armii Krajowej 254
85-689 Bydgoszcz
Polska**

NIP 554-039-23-83

REGON 093051226

tel: /+48 / 52 326 71 50

fax: /+48 / 52 326 71 58

info@mykamar.com